



**U.S. Army
Research Institute of
Environmental Medicine**

Natick, Massachusetts

TECHNICAL REPORT NO. T23-01
DATE October 2022

**US MARINE CORPS BODY COMPOSITION
AND MILITARY APPEARANCE PROGRAM
(BCMAP) STUDY**

Approved for Public Release; Distribution is Unlimited

United States Army
Medical Research & Development Command

DISCLAIMER

The opinions or assertions contained herein are the private views of the author(s) and are not to be construed as official or reflecting the views of the Army or the Department of Defense. The investigators have adhered to the policies for protection of human subjects as prescribed in 32 CFR Part 219, Department of Defense Instruction 3216.02 (Protection of Human Subjects and Adherence to Ethical Standards in DoD-Supported Research) and Army Regulation 70-25.

USARIEM TECHNICAL REPORT T23-01

**US MARINE CORPS BODY COMPOSITION AND MILITARY APPEARANCE
PROGRAM (BCMAP) STUDY**

Adam W. Potter ¹
Lyndsey J. Nindl ¹
Angie Pazmino ^{1,2}
Lara D. Soto ^{1,2}
Jason W. Hancock ¹
David P. Looney ³
William J. Tharion ³
David M. McEtrick ⁴
Karl E. Friedl ⁵

October 2022

¹ Thermal and Mountain Medicine Division, U.S. Army Research Institute of Environmental Medicine (USARIEM)

² Human Performance Branch (HPB), Training and Education Command (TECOM), US Marine Corps (USMC)

³ Military Performance Division, USARIEM

⁴ Marine Expeditionary Rifle Squad (MERS), USMC

⁵ Chief Physiologist, US Army

U.S. Army Research Institute of Environmental Medicine
Natick, MA | 01760-5007

REPORT DOCUMENTATION PAGE

*Form Approved
OMB No. 0704-0188*

The public reporting burden for this collection of information is estimated to average 1 hour per response, including the time for reviewing instructions, searching existing data sources, gathering and maintaining the data needed, and completing and reviewing the collection of information. Send comments regarding this burden estimate or any other aspect of this collection of information, including suggestions for reducing the burden, to Department of Defense, Washington Headquarters Services, Directorate for Information Operations and Reports (0704-0188), 1215 Jefferson Davis Highway, Suite 1204, Arlington, VA 22202-4302. Respondents should be aware that notwithstanding any other provision of law, no person shall be subject to any penalty for failing to comply with a collection of information if it does not display a currently valid OMB control number.

PLEASE DO NOT RETURN YOUR FORM TO THE ABOVE ADDRESS.

1. REPORT DATE (DD-MM-YYYY)		2. REPORT TYPE		3. DATES COVERED (From - To)	
4. TITLE AND SUBTITLE				5a. CONTRACT NUMBER	
				5b. GRANT NUMBER	
				5c. PROGRAM ELEMENT NUMBER	
6. AUTHOR(S)				5d. PROJECT NUMBER	
				5e. TASK NUMBER	
				5f. WORK UNIT NUMBER	
7. PERFORMING ORGANIZATION NAME(S) AND ADDRESS(ES)				8. PERFORMING ORGANIZATION REPORT NUMBER	
9. SPONSORING/MONITORING AGENCY NAME(S) AND ADDRESS(ES)				10. SPONSOR/MONITOR'S ACRONYM(S)	
				11. SPONSOR/MONITOR'S REPORT NUMBER(S)	
12. DISTRIBUTION/AVAILABILITY STATEMENT					
13. SUPPLEMENTARY NOTES					
14. ABSTRACT					
15. SUBJECT TERMS					
16. SECURITY CLASSIFICATION OF:			17. LIMITATION OF ABSTRACT	18. NUMBER OF PAGES	19a. NAME OF RESPONSIBLE PERSON
a. REPORT	b. ABSTRACT	c. THIS PAGE			19b. TELEPHONE NUMBER (Include area code)

TABLE OF CONTENTS

<u>Section</u>	<u>Page</u>
List of Figures.....	iii
List of Tables.....	iv
Acknowledgments	v
Executive Summary	1
Introduction	3
1. Task and purpose.....	3
2. Key questions for this report.....	3
3. Background – Known facts.....	3
• How did we get to the current body fat standards?	3
• Screening weight tables	4
• Method of fat assessment – “the tape test”	5
• Female tape test method deficiencies.....	6
• Ideal body fat.....	6
Methods	7
Study Procedures.....	8
Results.....	13
1. How do the USMC BCP weight screen and body fat standards perform?	13
2. Do the weight tables need to be adjusted?	16
3. How well does the tape test correctly categorize fatness in men and women?	19
3a. How well do other methods classify body fat compared to the tape	22
4. Are %BF limits matched to physical readiness and military appearance?	23
4a. Body fat and performance	23
4b. Body fat distribution, with respect to means and standards	24
4c. Body fat and appearance	26
5. Would a final lab assessment of body fat help to protect good performers?	27
Discussion and Implications	28
Summary and Conclusions	32
References.....	33

LIST OF FIGURES

<u>Figure</u>		<u>Page</u>
1	Circumference-based anthropometric measurements	9
2	SizeStream SS20 Three-Dimensional (3D) Circumference Scanner. (left) active scanning of a volunteer; (center) scanner setup at one of the study locations; (right) image from the company.	9
3	Dual-energy X-ray Absorptiometry system (iDXA, Lunar, General Electric) (left); scanning of a volunteer (right)	10
4	RJL Quantum IV Bioelectrical Impedance Analysis system commercial image (left); assessment of a volunteer (right)	11
5	InBody 770 Bioelectrical Impedance Analyzer commercial images (left and center); assessment of a volunteer (right)	11
6	Countermovement jump (CMJ) test on a calibrated force plate, assessing lower body explosive power	12
7	USMC Body Composition and Military Appearance Program (BCMAP)	13
8	Flow chart percent incidences for 1,436 Marine men tested in this study	15
9	Flow chart percent incidences for 692 Marine women tested in this study	15
10	Body mass index (BMI) to percent body fat (%BF) measured from DXA	17
11	Body mass index (BMI) to physical and combat fitness tests (PFT and CFT)	17
12	Body mass index (BMI) distribution for Marine men and women in this study (upper graphs) and BMI for Marine men and women from official weigh-in data (lower graphs).	18
13	Men body fat (%BF) by tape to dual-energy x-ray absorptiometry (DXA)	19
14	Women body fat (%BF) by tape to dual-energy x-ray absorptiometry (DXA)	20
15	Simple quadrants of classification for men (top) and women (bottom).	21
16	Simple comparison of body fat assessment methods to dual-energy x-ray absorptiometry (DXA) for men	22
17	Simple comparison of body fat assessment methods to dual-energy x-ray absorptiometry (DXA) for women	23
18	Box and whisker plot for ranges total scores of PFT (white boxes) and CFT (grey boxes) for men (left) and women (right)	23
19	Comparison of PFT and CFT scores to body fat (%BF) dual-energy x-ray absorptiometry (DXA)	24
20	Distribution of Marine men body fat (%BF) for the four age groups and their comparison to national averages.	25
21	Distribution of Marine women body fat (%BF) for the four age groups and their comparison to national averages	26
22	Representative mesh images of Marines across a range of %BF (by DXA) for both men (top row) and women (bottom row)	27

LIST OF TABLES

<u>Table</u>		<u>Page</u>
1	Sample of Marine men and women in the study	7
2	Overview of tests per visit and duration of each test in minutes (min)	8
3	Body mass index (BMI; kg/m ²) and body fat percent (%BF) upper standards	14
4	BCP breakout by age group	16
5	Simple correlation values (R ²) for each method compared to the DXA	22
6	BCP breakouts by age groups where DXA would identify misclassification	27

ACKNOWLEDGMENTS

The authors would like to thank all the men and women of the armed forces, as this work is ultimately in support of those who serve to protect us, and most especially the volunteers who gave their personal time to participate in this study.

We gratefully acknowledge the contributions of the extended study team including GySgt Travis Titopace, GySgt Clifford Souza, and Dr. Elisa Guerra (from Human Performance Branch (HPB), Training and Education Command (TECOM)); Dr. Brian Corner (Marine Expeditionary Rifle Squad (MERS)); Mr. Lucas Holden, CDT Hope Soucy, CPL Jasmine Robinson Espinosa, Mr. Stephen Landspurg, and Mr. Sai V. Vangala (from USARIEM).

This study would not have been possible without the partnership with the TECOM, HPB including Mr. Brian McGuire (HPB Branch Head), Maj Lindsey Slyman, Maj Kimberly Wade, Capt. Austin Wiemann, 1stSgt Nicholas Wheeler, and SSgt David Contreras. Their wholehearted support of this project and efficient problem-solving is a model for military research collaboration.

This study would also not have been possible without the full support of The Basic School (TBS), where the study began, where leadership proposed solutions to every problem and the entire team supported efficient testing. We are grateful to Col Joel Schmidt, Commanding Officer TBS, and his staff, LtCol Joshua Bullard, Maj Douglas Toulotte, Capt Stephen Lehrbass, and Capt Rexman Stitt. We are also grateful to Mr. Mark Richter, Gruntworks Director, MERS, for originally proposing USMC performance research and providing addition support of personnel and facilities.

This study was funded through Army RDT&E (ST Limits of Metabolic Performance initiative), the Defense Health Program, and through an equipment grant from the Office of Naval Research.

EXECUTIVE SUMMARY

Background:

Senior leaders from the US Marine Corps (USMC), US Army, and Department of Defense (DoD) expressed specific interest in understanding how DoD body composition standards are currently performing in terms of preventing obesity in the Armed Services, ensuring physical readiness of the force, and not inadvertently biasing against good physical performers (information paper annotated by SECARMY Esper and his statements during visit to USARIEM, 15 March 2019). Secretary Esper stated that some of the procedures implemented by USMC were a model for other services, with the specific example of linkage between fitness testing and body fat standards, where body fat standards are waived when excellent performance is already demonstrated through physical fitness testing (“It just makes sense, doesn’t it?”, 15 March 2019). The emergence of women in all military job specialties now makes it possible to study representative samples to reassess standards and procedures that were founded on what worked for men. Secretary Esper asked for more data to support the way ahead.

The USMC Training and Education Command (TECOM) invited USARIEM researchers to conduct on a multicenter study of the US Marine Corps Body Composition and Military Appearance Program (BCMAP). This report outlines the findings from the assessment of the BCMAP, intended to provide data and options for Marine Corps policies and standards. This study is one of several continuing studies on body composition and physical readiness of US Marines.

What was studied:

Body composition data was obtained from a convenience sample of 2,175 volunteer Marines, along with results from their most recent physical and combat fitness tests (PFT and CFT). The study occurred in three phases, first with a focus on 2nd Lieutenants at The Basic School (TBS), Quantico; then broadened to any Marines in the National Capital Region (NCR) who could travel to the Quantico, Virginia TBS test site; and finally, with time-limited sampling at Camp Lejeune, North Carolina (CLNC) and Camp Pendleton, California (CPEN). Marines were recruited through the Human Performance Branch (HPB) website advertisements and word of mouth, with special emphasis on (over) representation of Marine women. Prior to participation, participants were briefed on study procedures and then provided their informed signed research consent. They were then tested and measured over 20-30 minutes, while wearing the standard Marine Corps green-on-green physical training uniform (shorts, undershirts) without shoes. Additionally, women were asked to demonstrate a negative urine test for pregnancy. Key tests and measurements included height, weight, dual-energy x-ray absorptiometer (DXA) full body scan, single frequency recumbent bioelectrical impedance (BIA), standing multi-frequency BIA, countermovement jump (CMJ) test on a calibrated force platform, tape test circumferences, and 3D full body scan (only wearing compression shorts, and sports bra top, for women). Most recent record test results for PFT and CFT were obtained from each Marine.

Key Findings:

1. **Screening standards:** Women who fail the weight screen are likely to also fail percent body fat (%BF) by the tape test (99% of women); while 30% of men who fail to meet weight, do meet the %BF standards (i.e., large but lean, by %BF standards). Without the weight screen, an additional 9% of all men and 30% of all women would fail BCP.
2. **Weight standards:** Screening weights have a low/moderate correlation to %BF (correlation coefficient <0.4) and very low correlation to PFT and CFT performance of Marines (correlation coefficient <0.1).
3. **Tape test:** The tape test accurately categorizes 92% of men and women for body fat standards. A known bias in the tape prediction was observed with underestimation of %BF for the fattest and overestimation of %BF for the leanest Marines; 0.6% of men and 6.3% of women Marines were overestimated by tape (but within %BF limits by DXA), and 7.9% of men and 1.6% of women were underestimated by tape (but exceeded %BF limits by DXA).
4. **Percent body fat:** Average %BF across all four age groups of Marines represent a lean and healthy force (men, $22.0 \pm 6.3\%$; women, $29.8 \pm 6.6\%$ by DXA) that is below national averages (men, 3-4% lower; women 8-10% lower).
5. **Verification Assessment:** Study data confirmed that some Marines are misclassified by BMI and/or the tape test, and benefit from a higher quality “second chance” assessment of body fat (e.g., DXA or BIA).

Implications:

Immediate changes announced by the Marine Corps (MARADMIN 423/22) include an increase to female body fat standards, continued focus on the linkage between physical performance and body composition standards, and new consideration to an accurate “second check” body fat assessment (via DXA or qualified BIA) before any Marine is assigned to the Body Composition Program (BCP) or is being processed for discharge due to BCP failure. Further changes to the standards, following future research and review, may include elimination of screening weights and replacement of the tape test with a better method. A planned follow on to this study includes evaluation of an alternative practical and affordable body composition assessment method that will help to guide individual health and fitness behaviors, determine the most appropriate percent body fat and lower limits of lean mass, appropriate to high performing and healthy women and men in the Marine Corps.

INTRODUCTION

1. Task and Purpose.

The US Marine Corps (USMC) has led the Department of Defense (DoD) in physical readiness standards and served as a model for body fat standards to prevent obesity in the military. Following a review of fitness in the services in 1980, all military services were directed to implement body circumference-based body fat assessments to enforce body fat standards, following the example of the US Marine Corps (Study of Military Services' Physical Fitness, 1981). Previously, weight management in the DoD was based on weight-for-height tables that were known to be inappropriate in the assessment of large but lean individuals, and weight control was difficult to enforce. The services were directed to use weight-for-height tables only as a screening tool to identify large individuals who might be excessively fat. These individuals were to be further assessed using a circumference-based method for estimating percent body fat equation (the "tape test") and held to enforceable percent body fat (%BF) limits. This physical readiness strategy has served the USMC and DoD well for more than forty years but requires a re-examination to ensure that it still performs optimally and as intended (i.e., prevent obesity and promote physical readiness). Notable changes are increased representation of women in all military roles and the transition from a running culture in the 1980s to an increased focus on strength training in recent years (i.e., a shift from an aerobic to anaerobic training focus). These two changes warrant a new comprehensive review of the performance of the "tape test" and an assessment of readiness-related body fat standards in the context of sex-specific and physical training-related body physique (fat and muscle distribution) and anthropometry (body measurements).

The purpose of this study was to provide new data to support Marine Corps body composition screening, standards, and policies and to ensure that the current Body Composition and Military Appearance Program (BCMAP) continue to balance health, performance, and military appearance goals.

2. Key questions for this report

-
- 1) How do the USMC BCP weight screen and body fat standards perform?
 - 2) Do the weight tables need to be adjusted?
 - 3) How well does the tape test correctly categorize fatness in men and women?
 - 4) Are %BF limits matched to physical readiness and military appearance?
 - 5) Would a final lab assessment of body fat help to protect good performers?

3. Background – Known Facts

How did we get to the current body fat standards?

In 1980, an expert DoD panel recommended sex-specific body fat limits of 20 and 30 %BF for men and women, respectively (DoD Directive 1308.1, 1981; Study of Military Services Physical Fitness, 1981). These values were established from published studies that indicated average %BF of 15 and 25% for fit young men and

women (Fleck, 1983). An estimated statistical range around these averages, intended to include the majority of the fit young population, added 5% to the averages to establish the upper bounds of 20 and 30 %BF. The 20% limit for men was further validated with a comparison to aerobic fitness. In fit young Army recruits and Soldiers, 20 %BF corresponded to a predicted average 50 ml/kg/min $VO_{2\max}$ (Vogel et al., 1986; Friedl, 2012). However, without explanation, the DoD Directive reduced the recommended female limit from 30% to 28%, publishing military-wide body fat goals of 20 and 28% for all men and women.

The Army adopted 20 and 28% as the most stringent %BF limits for young men and women, and then provided +2% increases in three additional age groups (21-27; 28-39; 40+ years old). These standards were later adjusted upward by another +2% for female soldiers, returning to the original recommendation of the 1980 panel and including age-related increments. The Marine Corps decreased the recommended goals further by 2% for both men and women, establishing upper limits of 18 and 26 %BF for all men and women Marines (MCO 6100.10, 23 October 1980). The 18% value for men was derived from a 1974 study of 297 male Marines at Quantico measured for body fat (using underwater weighing) (Wright & Wilmore, 1974; MCO 6100.10, 1980). The mean %BF of this group of men (age 18-53, average age 28.7 years) was 16.5% (SD=6.2%) and a later report concluded that, based on these data, 18 %BF would provide a suitable body fat limit (Wright, Davis & Dotson, 1981). Young Marine women averaged 23% (SD=5.9%) in a parallel study to develop circumference equations for women (Wright, Dotson & Davis, 1980). The Body Composition Program (BCP) body fat standard was later amended to provide successive +1 %BF increases to men and women in three older age groups. Thus, current Marine Corps %BF limits range between 18 and 21% for men and 26 and 29% for women, with additional adjustments of +1% allowed for first class PFT and PFT performance (both ≥ 250).

These represent a lean body composition and are the most stringent %BF limits in the DoD.

Screening weight tables

The original intent of weight-for-height tables were to identify large individuals for further evaluation of obesity by a medical officer. Objective %BF standards (using the tape test) replaced the medical officer subjective evaluation, but weight tables were retained as a first tier screening tool. These tables are generally constructed from body mass index (BMI) relationships (BMI provides an appropriate scaling of body size as height increases, expressed as body weight, in kg, divided by stature squared, in cm; kg/m^2). Body size (or BMI) is a poor predictor of body composition, especially in a fitness-oriented military population (Foulis et al., 2021). National health goals were established in The Surgeon General's Report on Nutrition and Health as the 85% percentile of BMI in healthy young men and women measured in the National Health and Nutrition Examination Survey (NHANES) (Report on Nutrition and Health, 1988). These values were BMI 27.8 and 27.3 kg/m^2 for men and women. Ten years later, an expert panel provided national health goals of BMI 25.0 as a threshold body size, above which health risks increased for a variety of obesity-related diseases (e.g., type 2 diabetes, gout, gall bladder disease) (National Heart, Lung, and Blood Institute, Obesity Education Initiative, NHLBI Expert Panel, 1998). They also added waist circumference

goals, recommending that Americans remain below 40 inches (males) and 35 inches (females). In 2005, a USARIEM-sponsored study by National Center for Health Statistics (NCHS) demonstrated that the lowest mortality risk had moved from BMI <25.0 to 25.0-30.0 kg/m², previously defined as clinically “overweight” (Flegal et al., 2005). Current USMC screening tables are BMI <27.5 and <26.0 kg/m² for men and women, respectively. These screening weights are intended to identify individuals most likely to exceed their age-specific body fat limits, without missing too many overfat individuals but also avoiding the need to test a major portion of the force who are actually within the body fat limits. ***The USMC weight tables (screening standards) are more liberal than those used by the Army, equal to the tables applied only to soldiers over age 40 (the Army weight screening are more stringent for three younger age groups compared to the USMC).***

Method of fat assessment – “the tape test”

Military circumference-based equations were first developed by the USMC (Wright & Wilmore, 1974; Wright, Dotson & Davis, 1980, 1981). These built on earlier research testing many combinations of anthropometric measurements (skinfold thicknesses, body circumferences, and body breadths) against body density determined by underwater weighing; abdominal girth was a consistently high correlate that emerged from the studies and was key to the USMC equations for both men and women. The DoD Directive required services to develop circumference-based methods for practical %BF standards enforcement but did not prescribe a particular predictive equation. As a result, Army, Navy, and Marine Corps each implemented separate sex-specific equations. The male equations were very similar and all focused on an abdominal circumference, with body size adjustment from a neck circumference. It was recognized immediately that predicting body composition of women from body circumferences was much more difficult. The Army had to choose between ~35 different “best fit” equations derived from the data from the Army Body Composition Study; none of these were deemed very suitable even for the original test sample from which they were derived (Vogel et al. 1988). The Marine female equation was derived from a statistical sampling of 226 Marines (ages 18-47) assigned to Quantico, Virginia. Mean %BF determined by hydrostatic weighing was 23 ± 6 and 22 ± 6 in test and validation samples, respectively. %BF was predicted from biceps, forearm, neck, abdomen, and thigh circumferences (Wright, Dotson & Davis, 1980). After a General Accounting Office (GAO) review demonstrated predictions between 22 and 40 %BF in one woman using each of the different service equations, the services all agreed to adopt the Navy equations as the best circumference-based percent body fat predictive equations (General Accounting Office, 1998; Hodgdon & Beckett, 1984a, Hodgdon & Beckett, 1984b). The method became part of the standard, with the equations specified in the DoD Instruction (DoDI). The equation for women was further validated across a range of female race/ethnicity and compared to a four compartment model (fat mass, bone mineral, water and residual) of body composition (better than the two compartment model (fat mass, and fat free mass) from hydrostatic weighing which does not distinguish variability in bone mass and total body water components of the fat-free mass) (Van Loan, Hodgdon & Kujawa, 2001). ***The USMC currently uses the predictive equations for %BF for men and women that are officially prescribed in the DoDI.***

Female tape test method deficiencies

Abdominal circumference is a strong predictor of total body fat in males and is the key factor in the male predictive equation. Coincidentally, this site of preferential fat deposition in males is strongly associated with aerobic fitness, military appearance, and obesity-related health outcomes. The current tape test works well for categorizing men for within or over militarily relevant fat standards. Prediction of body fat from any combination of anthropometric measurements is a much bigger challenge for women. The inclusion of hip circumference along with an abdominal measurement improved the prediction of percent body fat in women, and these two sites (waist and hip circumferences) also reflect two of the most labile fat depots, affected by exercise and nutrition; others such as thigh fat, are less affected by exercise and nutrition (Rebuffe-Scrive et al. 1985, Rebuffe-Scrive et al., 1989). The predictive error of the female equations is worse than that of the male equations (Potter et al., 2022a). The wider variability of body fat deposition in women compared to men, and even between women, reduces the accurate prediction of %BF from one generalizable female equation based on circumferences. ***Anthropometry does not assess total body fat in women as well as in men.***

Ideal body fat

The 1980 expert panel noted that *the most stringent percent body fat limits* are associated with appearance ratings (Hodgdon, Fitzgerald & Vogel, 1990); while *the most liberal %BF limits* would be associated with obesity-related health outcomes (Gallagher et al., 2000); and associations with various types of physical performance would fall somewhere between appearance and health optimums. Within physical performance associations, aerobic endurance sports such as marathon running benefit from the lowest possible body fat, where moving every additional ounce of tissue (of any kind, including lean mass) has an associated energy cost (Kenney & Hodgson, 1985). By contrast, strength performance benefits from high lean mass, irrespective of the quantity of fat (Potter et al., 2022b). Ideal %BF varies even within football positions, with linemen carrying more mass, including fat and lean mass, where wide receivers need speed and agility at lower fat mass, similar to short- and middle- distance runners (Bosch et al., 2019). ***“Ideal” or “optimal” body fat varies according to the desired outcome.***

Ageing-related changes in key hormones such as growth hormone, IGF-1, and sex steroids (e.g., testosterone and estrogen) further modify body composition with typical gradual reduction in lean mass and increase in fat mass, including distribution of fat mass within muscle tissue (Junnila et al., 2013). A non-obese physically fit man and woman will generally carry higher %BF and less lean mass at age 40 than they carried at age 20 (Pollock et al., 1997). These changes happen despite recent finding that cellular metabolism remains stable between the ages of 20 and 60 (Pontzer et al., 2021). These age-related changes have a large degree of variability based on individual genetic factors (Bell, Walley & Froguel, 2005); personal health and fitness habits moderate these changes but for whom and to what extent is still poorly defined (Bouchard, 2008). ***There is an actual, but poorly quantified increase in %BF with age for most people.***

METHODS

This study included three main phases, with consideration for more beyond this report. One portion of the study included a pre-test/post-test assessment of US Marines training to be new 2nd Lieutenants, via The Basic School (TBS) at Marine Corps Base Quantico, Virginia. This first phase focused on recruitment of a convenience sample of young men and women in the six-month long USMC Basic School, with over-representation of the women (approximately 10% of Marines officers entering TBS are women). Volunteers for the phase one sample included 256 (men, n=181; women, n=75). The second and third phases of the study focused on recruitment of active duty Marines, with a characterization design that included a single study visit. The second phase of the study included a convenience sampling from active duty Marines within the National Capital Region (NCR) using the test location at TBS Quantico, VA. The third phase of the study expanded test locations to major USMC bases, Camp Lejeune, North Carolina (CLNC), and from Camp Pendleton, California (CPEN). Volunteers included a total of 1,919 (men, n=1,255; women, n=662; transgender, n=2). The total complete dataset for the study included 2,175 active duty Marines (Table 1).

Table 1. Sample of Marine men and women in the study*

Age group (years)	Men (n=1,436)				Women (n=737)			
	17-25	26-35	26-45	46+	17-25	26-35	26-45	46+
N	495	564	315	62	281	290	154	12
Mean years of active duty	5.6	9.9	19.3	25.7	3.1	9.5	17.9	28.7

* 2 transgender Marines not included within the table

Data collected from each population and location were used to characterize body composition, body stature and physical performance of contemporary healthy fit young men and women in an elite cohort (motivated Marine Corps officers in TBS), as well as a broader sample to evaluate how well current DoD procedures for body fatness classify individuals across these groups, and to provide a descriptive reference dataset for comparisons with other specialized performers.

The study received approval from the US Army Medical Research and Developmental Command Institutional Review Board (IRB) and by the US Marine Corps IRB. All participants were briefed on the purpose, risks, and benefits of the study and provided written informed consent before testing.

Phase one volunteers (TBS Marines) were asked to complete two 35 minute (min) visits: visit 1: Pre-Test (within 7 days of entry into TBS) and visit 2: Post-Test (within 14 days of exit from TBS). Only their data from the pre-test visit is included in this analysis and report. Volunteers from phases two and three (NCR, CLNC, and CPEN), were asked to complete a single study visit (visit 1: Test 35 minute (min)). Table 2 summarizes the test design for each visit.

Table 2. Overview of tests per visit and duration of each test in minutes (min).

Procedure	Duration
1. Demographics / Background Questionnaire	3 min
2. Anthropometrics (height, weight, circumferential tape measures)	5 min
3. Three-dimensional (3D) Body Surface Scan	5 min
4. Dual-energy X-ray Absorptiometry (DXA)	12 min
5. Bioelectrical Impedance Analysis (BIA)	5 min
6. Counter Movement Jump (CMJ)	5 min
Total	35 min

Study Procedures:

1. Demographics / Background Questionnaire

Volunteers were asked to complete a demographics and baseline questionnaire at the beginning of their study visit. This questionnaire included dietary and exercise habits, demographical information (age, race, ethnicity, etc.), as well as self-reported sections for military information (fitness scores, rank, years of military service, etc.).

2. Anthropometrics

Baseline anthropometric measurements were taken while volunteers wore standard physical fitness uniform ('green-on-green' PT uniform or similar) using standard techniques and equipment. Standing height was measured to the nearest 1 mm. Subjects were measured in bare or stocking feet while standing on a flat surface, feet together, knees straight, and the head, shoulder blades, buttocks, and heels in contact with the stadiometer. Body weight was measured during each visit using a calibrated electronic scale accurate to 0.1 kg.

Circumference “Tape Test” measurements

Circumference measurements (i.e., “the tape test”) were taken by a trained study team member at the neck, waist, and hips in accordance with the method described in MCO 6100.10. Measures were taken by holding the tape flat against the skin to measure neck and abdomen (at the level of the umbilicus), and neck, waist (at the thinnest portion of the abdomen), and hips (at the greatest protrusion of the buttocks). While the standards call for specific measures for men and women; for the study, men and women were both measured at all sites (i.e., everyone was measured the same). Measurements were made in triplicate using the USMC standard tape measure (MyoTape, AccuFitness LLC, Denver, CO) and recorded at the nearest 5 mm.

While all members of the team were trained on the proper methods of obtaining appropriate measurements; to control for consistency, taping was done by a limited number of individuals on the team for most of the assessments. Measurement of neck circumference and abdominal circumference (at the navel) are illustrated (Figure 1). For this report, the neck and abdominal (navel) circumference for men and, the neck, abdominal (natural waist), and hip/buttocks circumference for women were measured and used to calculate the “tape test” predicted percent body fat of men and women according to procedures prescribed by the BCP order (MCO 6100.3A, 2021).

Figure 1. Circumference-based anthropometric measurements.



3. Three-dimensional (3D) Whole Body Surface Scanning

Each volunteer was assessed using a 3D scanner (SS20 Scanner, SizeStream, Cary, NC), that automated and computerized measurements of body circumferences, lengths, surface area, and volume based on anatomical landmark locations. Volunteers were provided a swim cap to wear if hair could not be tightly contained and were asked to complete body scan measurements while only wearing form-fitting compression shorts; while women were asked to also wear a sports bra. Each volunteer stood with arms straight, relaxed, and abducted from the body on the platform for the 3D body surface scan (Figure 2). Percent body fat was based on Harty et al. (2020).

Figure 2. SizeStream SS20 Three-Dimensional (3D) Circumference Scanner. (left) active scanning of a volunteer; (center) scanner setup at one of the study locations; (right) image from the company.



4. Dual-energy X-Ray Absorptiometry (DXA)

Body composition was assessed using dual-energy x-ray absorptiometry (DXA) (iDXA, GE Healthcare, Madison, WI) (Figure 3). The DXA technique allows the non-invasive assessment of soft tissue composition by region with a precision of 1-3% (Toombs et al., 2012). These data were used to calculate lean body mass, fat mass and bone mineral density. Data analysis relied on manufacturer supplied algorithms (Encore, version 13.5, Lunar Corp., Madison, WI). Data from the DXA was considered the criterion measure of body composition for comparison of methods.

Research staff calibrated the scanner to external standards prior to data collection. Volunteers were asked to lay motionless supine (face-up) on the DXA densitometer table for ~10 minutes during the scan. Women volunteers were asked to take a pregnancy test ≤ 48 h before the DXA scan, to verify they were not pregnant.

Figure 3. Dual-energy X-ray Absorptiometry system (iDXA, Lunar, General Electric) (left); scanning of a volunteer (right)



5. Bioelectrical Impedance Assessment (BIA)

BIA is a non-invasive tool which functions based on the principle that electric current flows at different rates through the body depending on its composition and is related to conductor length, cross section, and frequency (Potter et al., 2022c).

Total body water (TBW) and calculated body composition measures were assessed using bioelectrical impedance analyses (BIA, 50 kHz) via the RJL Quantum system (RJL Systems, Clinton Township, Michigan) (Figure 4) and from a multi-frequency standing system (InBody 770; Cerritos, California) (Figure 5). The RJL system measures were conducted using procedures outlined in the next paragraph and body composition was calculated from anthropometry and 50 kHz resistance measurements using the equations of Sun et al. (2003). All the measurements obtained from the InBody were based on proprietary algorithms.

At the end of the DXA scan each volunteer remained in a relaxed supine position, on a nonconductive pad overlaying the wooden DXA platform, and total body resistance was measured at 50 KHz between left hand and left foot. Disposable

electrodes were placed mid-wrist on a line bisecting the ulnar head and at the base of the middle finger and mid-ankle on a line bisecting the medial malleolus and at the base of the middle toe (Figure 4). Volunteers were asked to keep their arms and legs abducted at a 30° angle from the trunk to avoid medial body contact by upper and lower extremities.

Using the InBody system, BIA was assessed with the subjects standing on the system scale in barefeet, while holding onto handgrip electrodes (non-stick) (Figure 5).

Figure 4. RJL Quantum IV Bioelectrical Impedance Analysis system commercial image (left); assessment of a volunteer (right)



Figure 5. InBody 770 Bioelectrical Impedance Analyzer commercial images (left and center); assessment of a volunteer (right)



6. Counter Movement Jump (CMJ) Performance

Lower body force production (average and peak power) and movement kinematics was assessed via counter-movement vertical jump (CMJ) on a force platform (AccuPower Portable Force Platform, AMTI, Watertown, MA). Volunteers were asked to complete a standardized dynamic warm-up protocol prior to execution of study procedures. The dynamic warm-up consisted of 10 body weight squats, 10 body weight walking lunges, five progressive body weight squat jumps, and three maximal body weight CMJs before data collection.

Volunteers were asked to step onto the force platform and remain still for a period of 5 seconds. Volunteers were then asked to jump vertically for maximal height and land with both feet striking the platform simultaneously. Other than the task instruction, subjects were not given any feedback or corrective coaching on their landing technique. Each volunteer was provided with a one-minute rest period after the warm-up and 15 s of rest between each of the three jumps (Figure 6). Full data was captured using the commercial software (AccuPower Solutions); while calculations for CMJ height, velocity, and total power were recorded for analyses. Analyses of these CMJ data in combination with deeper analyses of the PFT and CFT data will be reported separately.

Figure 6. Countermovement jump (CMJ) test on a calibrated force plate, assessing lower body explosive power



RESULTS

The main results from this study are outlined to model the five main questions posed at the beginning, namely: 1) *How do the USMC BCP weight screen and body fat standards perform?* 2) *Do the weight tables need to be adjusted?* 3) *How well does the tape test correctly categorize fatness in men and women?* 4) *Are %BF limits matched to physical readiness and military appearance?* 5) *Would a final lab assessment of body fat help to protect good performers?*

1. How do the USMC BCP weight screen and body fat standards perform?

Using data collected from the study, we assessed performance of the Marine Corps BCPMAP and BCP. The current official process (graphically outlined in Figure 7) includes a number of steps that begin with a height and weight screening (i.e., assessment for BMI). The standards for BMI and %BF are shown in Table 3. If a Marine passes their BMI screening (men ≤ 27.5 and women ≤ 26 kg/m²), then they do not get further assessments; however, if they fail this screening, they are further assessed for percent body fat (%BF) using the tape test. There are additional performance related allowances; where if Marines have both PFT and CFT scores ≥ 250 they are provided an additional 1% to their allowed body fat limit, and if their PFT and CFT scores are both ≥ 285 , they are allowed an exemption from their body fat standards for that cycle. Additionally, there is a requirement for good military appearance. Overall failure through this screening process can result in an individual Marine being enrolled into the BCPMAP.

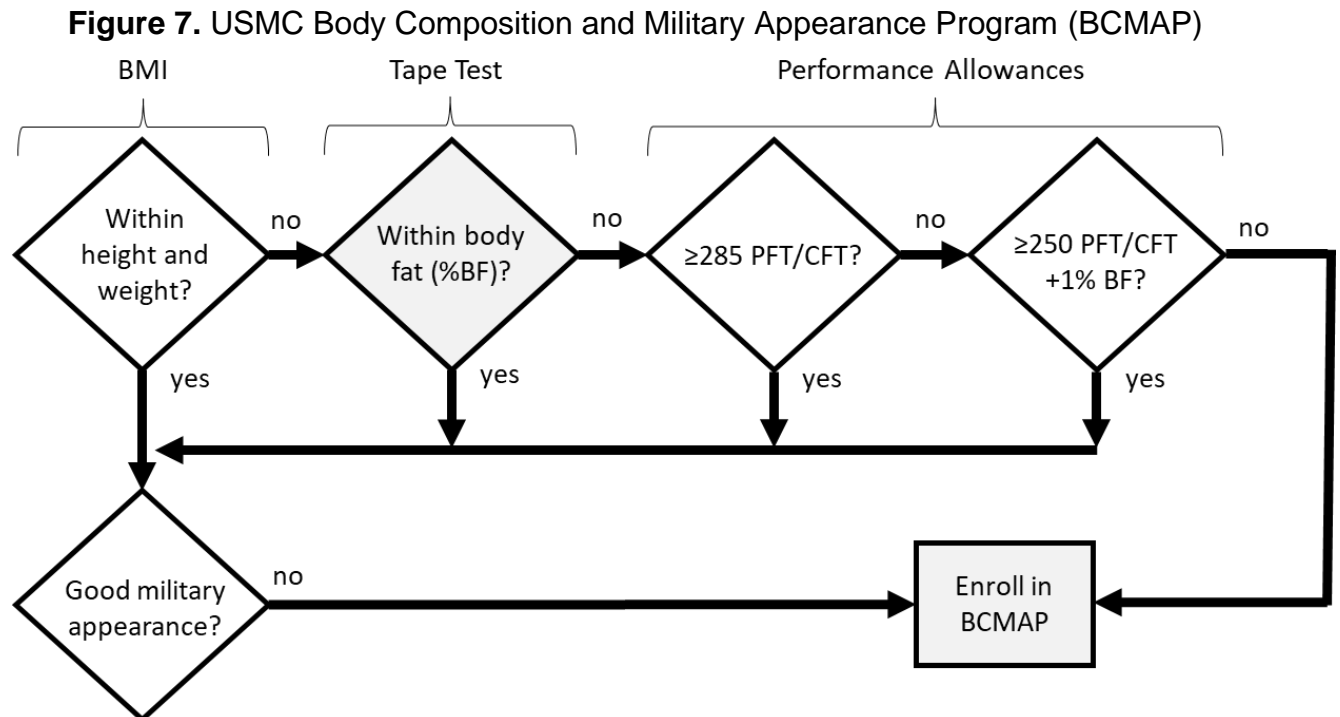

Table 3. Body mass index (BMI; kg/m²) and body fat percent (%BF) upper standards

Age group (years)	Men				Women			
	17-25	26-35	26-45	46+	17-25	26-35	26-45	46+
Allowable Body mass index (BMI)	27.5 kg/m ²				26 kg/m ²			
Allowable Body Fat Percent (%BF)	18%	19%	20%	21%	26%	27%	28%	29%
With PFT & CFT ≥250	19%	20%	21%	22%	27%	28%	29%	30%
With PFT & CFT ≥285	Exempt				Exempt			

To adequately assess the BCMAP / BCP, the study design and data collection allowed for assessment of Marines at each step. Figures 8 and 9 illustrate the proportion of individuals from this experimental sampling as they would pass through the BCMAP screening and standards gates as prescribed by MCO 6100.10; however, the data here is shown for %BF regardless of height and weight (BMI) status. Additionally, Table 4 shows the incidence assessment by age group.

For men, 683 (48%) exceeded BMI screening limits and 609 (42%) exceeded %BF standards by tape test; while of this entire group, 487 (34%) exceeded both BMI and %BF by tape. For women, 288 (42%) exceeded BMI screening limits and 490 (71%) exceeded %BF standards by tape test; while of all this group, 286 (41%) exceeded both BMI and %BF by tape. Takeaways from this: 1) if women exceeded the weight screen (BMI >26.0 kg/m²), they almost certainly exceeded their age-specific %BF limits, and 2) ~30% of overweight men (BMI >27.5 kg/m²) still met their %BF standards by tape test. This specifically indicates a mismatch between BMI limits and %BF standards for women. There were no notable trends with age for either men or women in this sample.

In this sample, 37 (3%) men and 16 (2%) women exceeded weight and fat limits but demonstrated scores of ≥285 on both the PFT and CFT. These individuals would receive an exemption from fat standards for this excellent physical performance. Of all the Marines in this sample, 25 (2%) men and 40 (6%) women failed weight screen and fat standards but would be rescued by a second tier %BF assessment using DXA. In other words, 2% of men and 6% of women were misclassified into the BCMAP by the tape test.

If there was no BMI screen, 600 (42%) men and 490 (71%) women would exceed standards based on %BF for their respective age group (highlighted in the dashed boxes in Figures 8 and 9). This indicates that a majority (71%) of women actually exceed their current %BF standards, but many are protected by the current BMI screening limits. Note that a larger proportion of men and women, not precisely defined by this study, are protected by height for weight (BMI) screening when they have time to prepare for the annual weigh in (described in the following section). This means that more Marines are likely to be within standards at their official fleet weigh-in than the numbers obtained in this study which the participants knew was not for record.

Figure 8. Flow chart percent incidences for 1,436 Marine men tested in this study

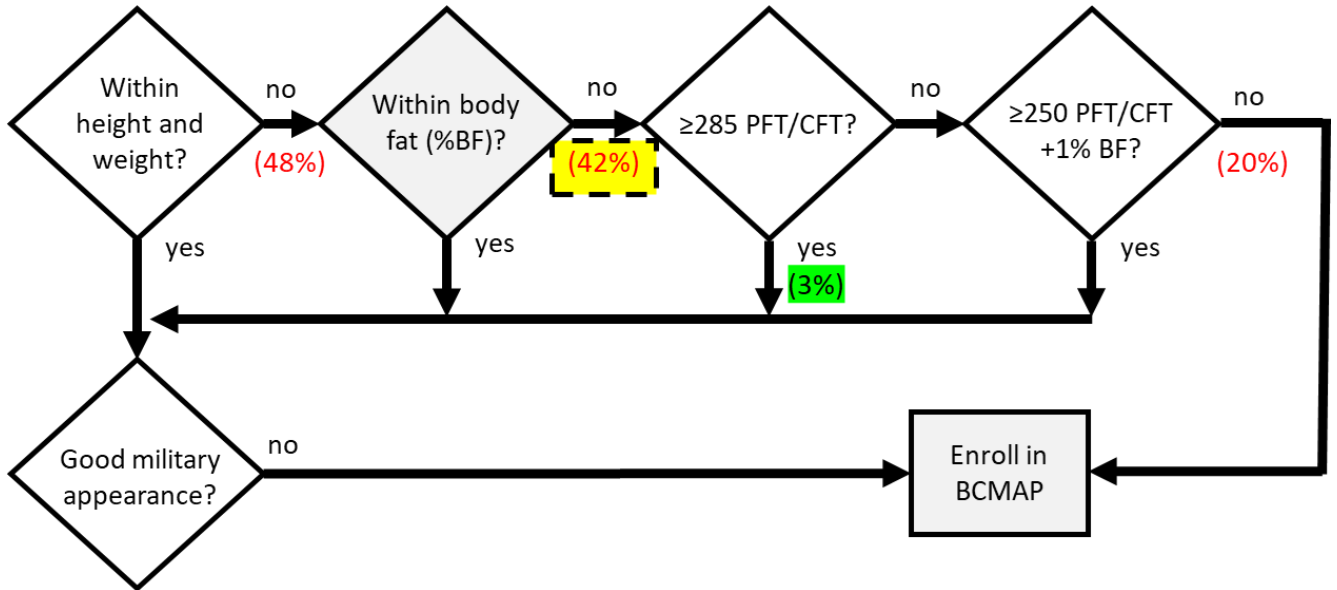
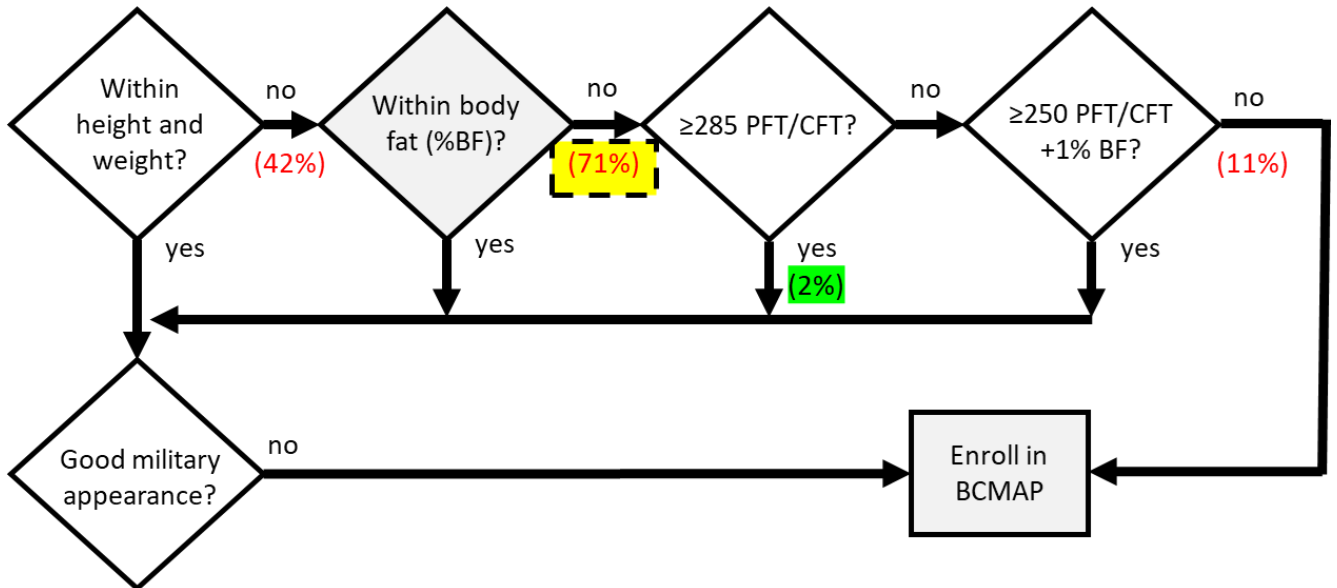

Figure 9. Flow chart percent incidences for 692 Marine women tested in this study.



Note: 45 women Marines postpartum ≤12 months not included in this assessment

Table 4. BCP breakout by age group

	Men (n = 1,436)				Women (n = 692)			
Age group	17-25	26-35	36-45	46+	17-25	26-35	36-45	46+
N =	495	564	315	62	273	263	145	12
Exceed weight (BMI)	27.5 kg/m ²				26.0 kg/m ²			
# (% of sample)	186 (38%)	286 (51%)	181 (58%)	30 (48%)	109 (40%)	112 (43%)	63 (43%)	4 (33%)
Total (proportion)	683 (48%)				288 (42%)			
Exceed %BF by tape	18%	19%	20%	21%	26%	27%	28%	29%
# (% of sample)	163 (33%)	255 (45%)	167 (53%)	24 (39%)	202 (75%)	175 (67%)	105 (72%)	8 (67%)
Total (proportion)	609 (42%)				490 (71%)			
Exceed both weight (BMI) and body fat (%)								
# (% of sample)	136 (28%)	195 (35%)	135 (43%)	21 (34%)	109 (40%)	111 (42%)	62 (43%)	4 (33%)
Total (proportion)	487 (34%)				286 (41%)			
Exceed weight & body fat but post 285/285 PFT/CFT								
# (% of sample)	3 (0.6%)	20 (3.5%)	8 (2.5%)	6 (9.7%)	7 (2.6%)	13 (4.9%)	2 (1.4%)	0 (0.0%)
Total (proportion)	37 (3%)				22 (3%)			

2. Do the weight tables need to be adjusted?

Analyses of the current standards found weight tables shield 8.9% of men and 30.3% of women. That is to say, using the weight tables and associated %BF from the tape test, these individuals exceeded their body fat standards but fell below the BMI screening limit. This highlights an area for careful consideration when proposing changes to or removal of these existing standards.

Figure 10 shows the relationship between the weight for height screen (based on BMI) and %BF measured from the DXA, for both men and women Marines. Figure 11 shows the relationship between BMI and performance scores (PFT and CFT). There is only a low/moderate correlation between BMI and %BF (men, $R^2=0.31$; women, $R^2=0.41$) and very low correlations between BMI and PFT and CFT for both men (PFT, $R^2=0.08$; CFT, $R^2=0.05$) and women (PFT, $R^2=0.10$; CFT, $R^2=0.04$). These data indicate that the relationship between BMI and %BF, and the relationship between BMI and CFT, PFT performance testing is poor within this restricted range of fit, non-obese Marines. The relationship is stronger in other populations that stretch across a wider range of BMI. In general, BMI does not appear to be a useful discriminator of %BF or performance in Marines.

Figure 10. Body mass index (BMI) to percent body fat (%BF) measured from DXA

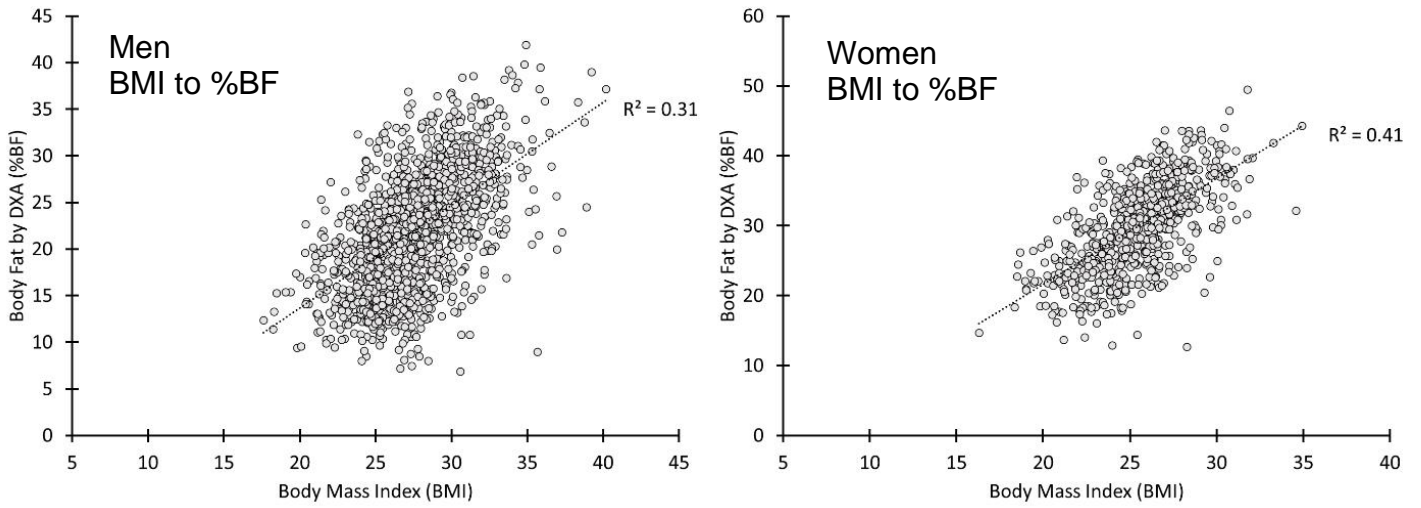

Figure 11. Body mass index (BMI) to physical and combat fitness tests (PFT and CFT)

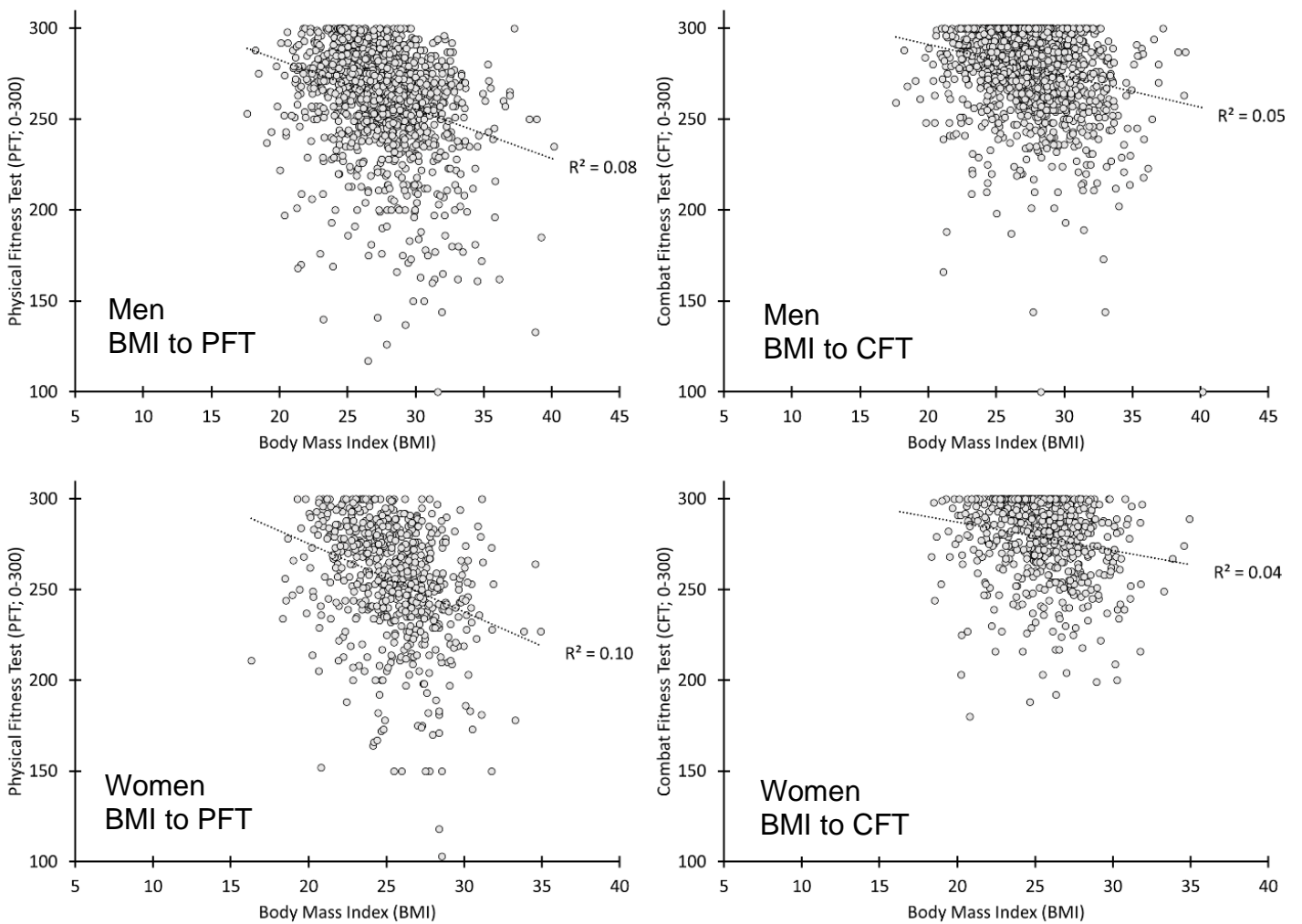
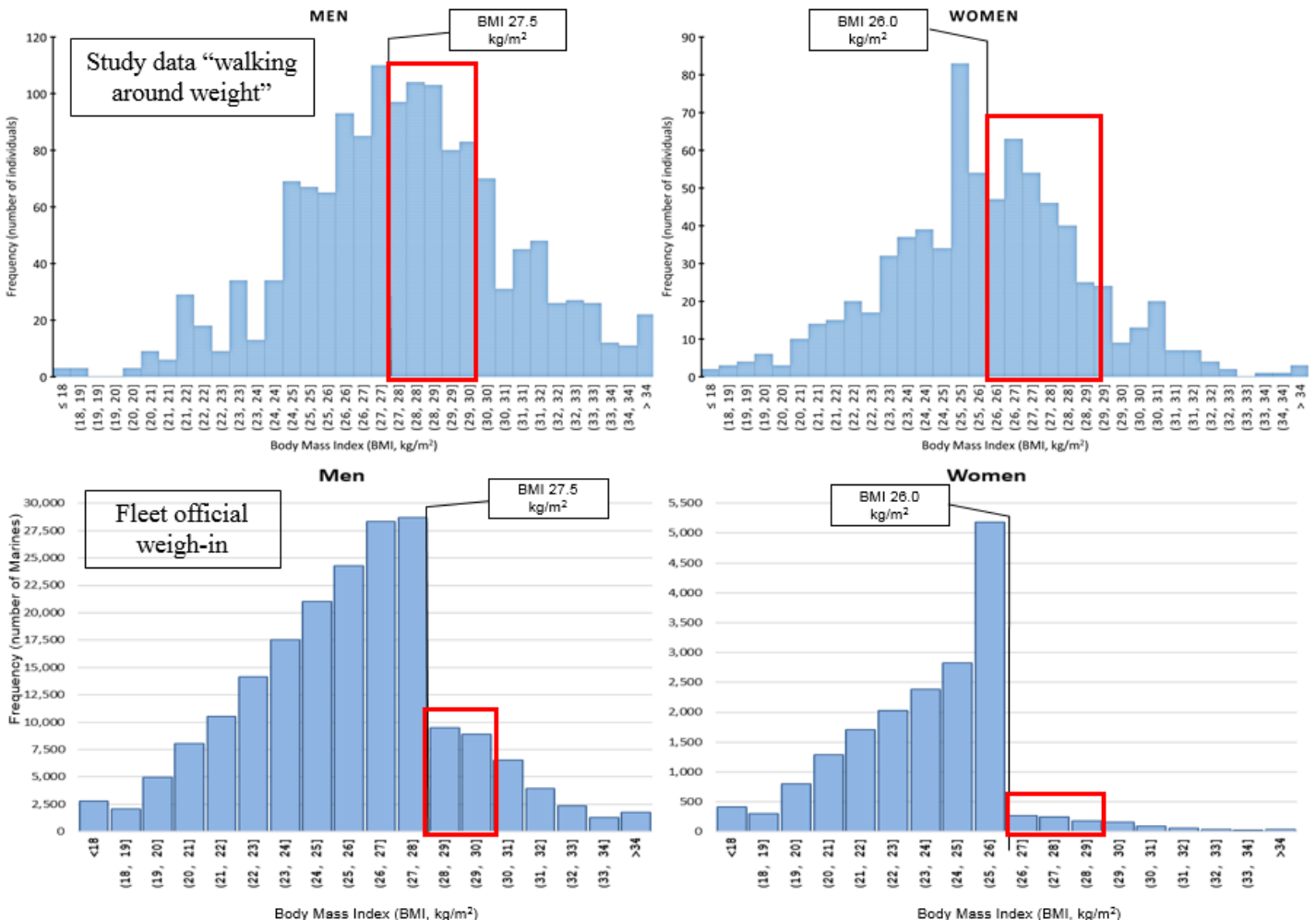

Figure 12 shows the body mass index (BMI) distribution of men and women from the entire study and from official fleet weigh-in data. The upper two graphs show the normal distribution of weight-for-height (expressed as BMI) in this sample, with 47% of men and 42% of women exceeding their screening weight limits (men, 27.5 and women, 26.0 kg/m²). In this sample, 38% of men and 55% of women were within 10 pounds (4.5 kg) over their limits. The lower figures in Figure 10 show the fleet USMC official weigh-in data, demonstrating a very non-normal (skewed) distribution with a sharp break at the respective screening weight limits for men and women (this data is not specifically from the group of volunteers studied in this sample). The difference between these two graphs and the previous two graphs highlights a normal “walking around weight” that is modified through short term weight loss practices by individuals to ensure compliance for official weigh-ins and avoidance of further body fat assessment.

Figure 12. Body mass index (BMI) distribution for Marine men and women in this study (upper graphs) and BMI for Marine men and women from official weigh-in data (lower graphs). Red callouts indicate individuals that are within 10 pounds of exceeding the weight screen. **Note** these illustrations are presented as integers; male BMI limit is 27.5 kg/m².



3. How well does the tape test correctly categorize fatness in men and women?

Performance of the circumference based (tape test) was compared to DXA assessed %BF. This produced a known overestimation of %BF for lean Marines and underestimation of %BF for Marines with higher relative fat (Figures 13 and 14). The method was most accurate in the region of the fat standard limits. Figures 13 and 14 show the comparison of individual %BF by tape to DXA for men (Figure 13) and women (Figure 14), where the solid diagonal line represents the line of identity signifying greatest accuracy of the tape, and the two dashed diagonal lines representing over- and under-predictions based on >5 , ≤ 5 % (over predictions being higher on the figure and under predictions being lower on the figure relative to the line of identity). These graphs describe accuracy and bias of the tape compared to DXA but do not directly address the question of correct categorization of individuals for purposes of the BCMAP, as this is shown in the next section.

Figure 13. Men body fat (%BF) by tape to dual-energy x-ray absorptiometry (DXA)

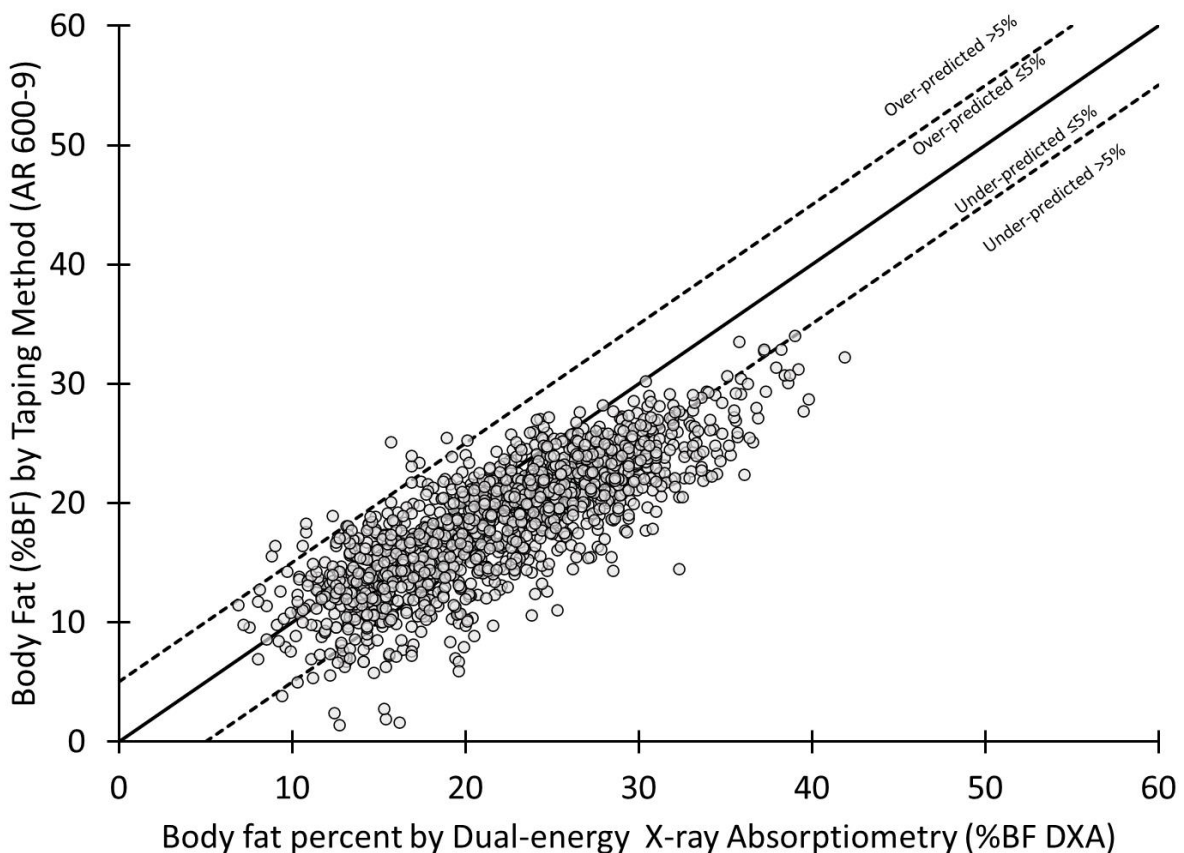

Figure 14. Women body fat (%BF) by tape to dual-energy x-ray absorptiometry (DXA)

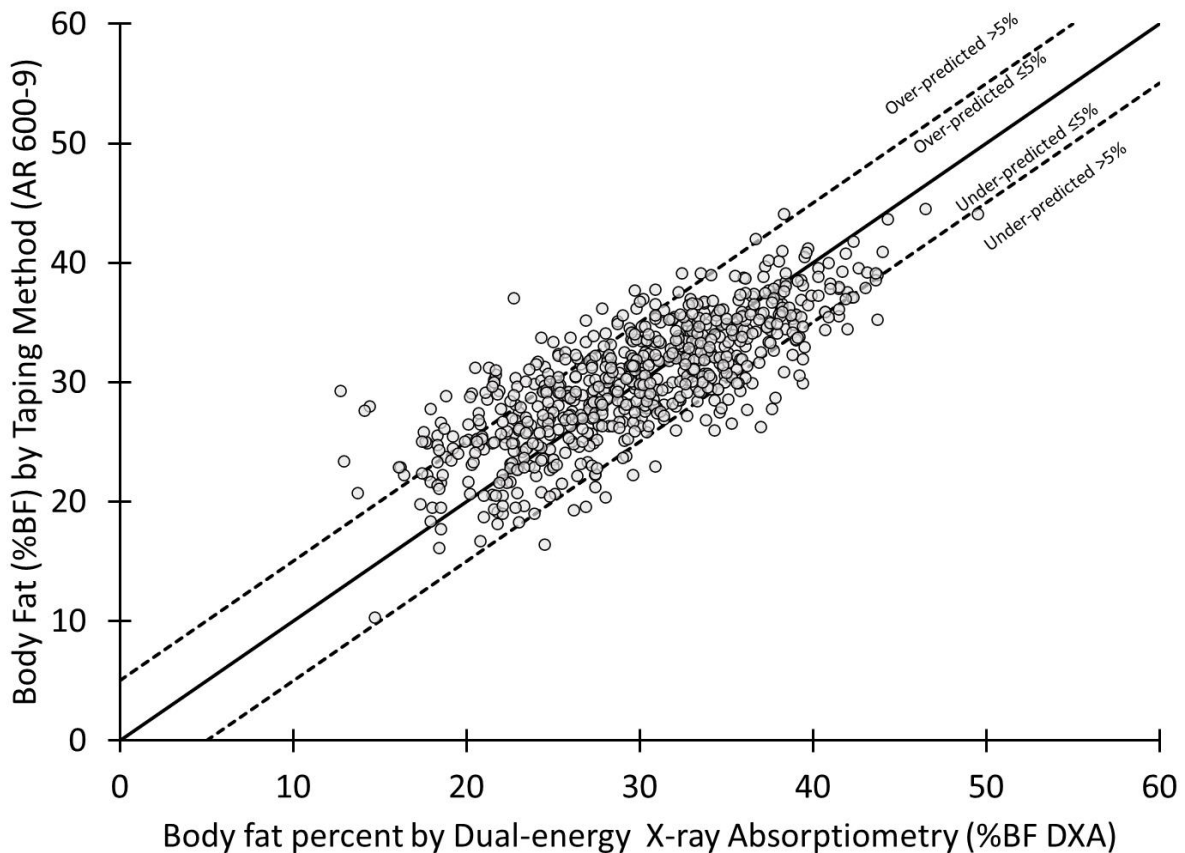
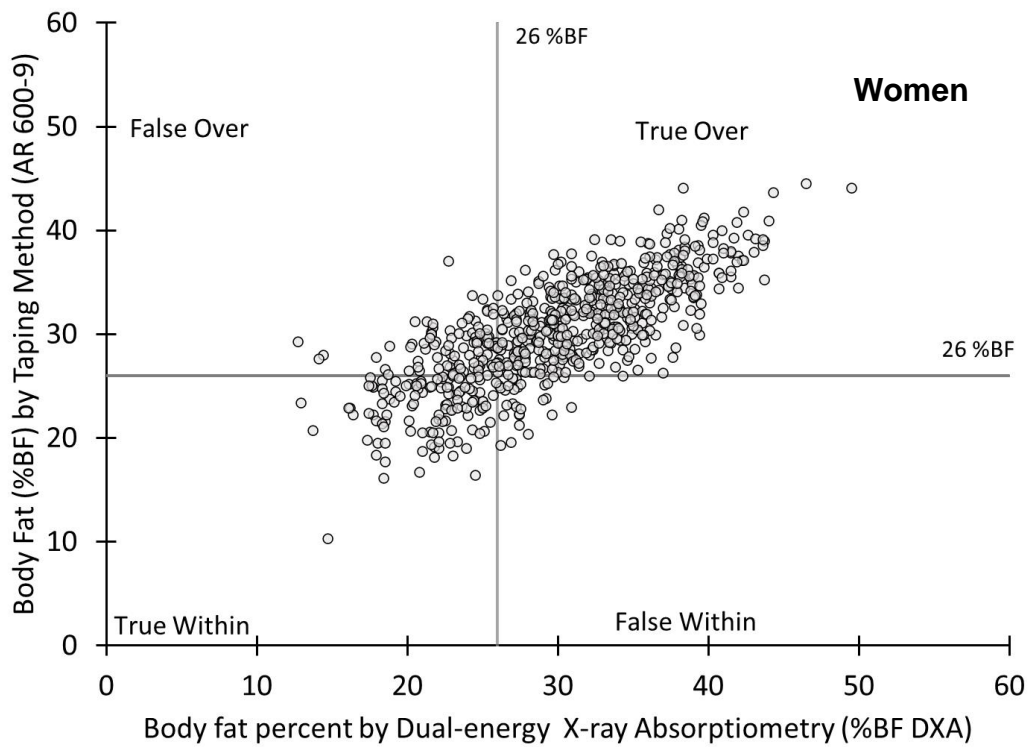
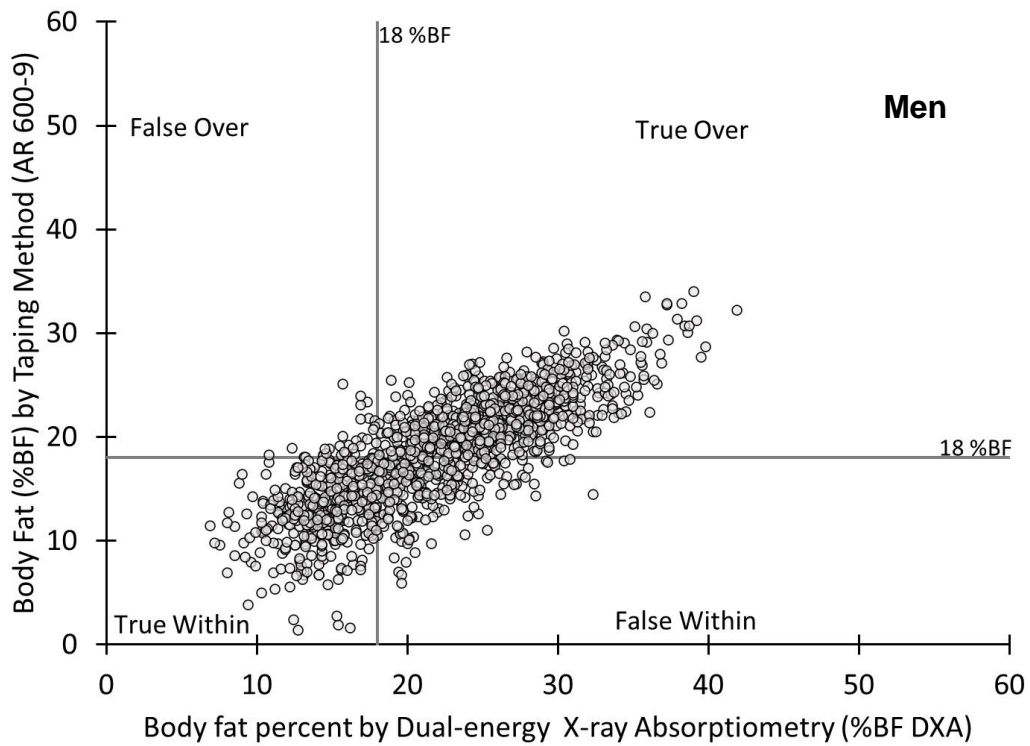

Figure 15 shows simple quadrants of classification for men (top) and women (bottom). Most important to the BCMAP is that individuals be binned to the correct quadrants of “true positives” and “true negatives” or true over standards and true under standards. For illustration, horizontal and vertical guidelines on the graphs show classification quadrants using the %BF limits for the youngest Marines (the full range across four age groups is 18-21% for men and 26-29% for women); 91.5% of men and 92.1% of women were correctly classified by tape. Misclassification of individuals who are within %BF standard as “exceeding %BF by tape” was 0.6% of men and 6.3% of women, while misclassification of those who are actually over %BF standards to be “within %BF standard by tape” was 7.9% of men and 1.6% of women (these calculations were based on the appropriate sex and age %BF limits – the other three age category %BF limits are all illustrated in the two figures). For purposes of BCMAP classification, some of these over %BF misclassifications would be protected by the initial weight-for-height (BMI) screen and never assessed for %BF by tape.

Figure 15. Simple quadrants of classification for men (top) and women (bottom).



3a. How well do other methods classify body fat compared to the tape test?

An evaluation of several other %BF methods was conducted, comparing the %BF estimates to DXA %BF. In addition to the tape test, this included: single frequency bioelectrical impedance (SF-BIA) (RJL system), 3D body scanner (SizeStream device), and 4) multi-frequency bioelectrical impedance analysis (MF-BIA) (InBody 770). Figures 16 and 17 show simple correlation-based performance of each of these methods for men (Figure 16) and women (Figure 17). There was greater precision in the predictions from the standing MF-BIA (InBody 770) compared to the other methods for both men and women (Table 5). It should be noted that the MF-BIA data was obtained from a subset (n=795) of the dataset. Additionally, this correlation assessment does not directly relate to accuracy. The first three of these comparisons have been reported in detail in two peer-reviewed publications (Potter et al., 2022a, Potter et al., 2022c).

Table 5. Simple correlation values (R^2) for each method compared to the DXA.

Method	Men	Women
Tape Test	0.64	0.61
SF-BIA (RJL)	0.57	0.72
3D Scanner (SizeStream)	0.57	0.58
MF-BIA (InBody 770)	0.75	0.85

Figure 16. Simple comparison of body fat assessment methods to dual-energy x-ray absorptiometry (DXA) for men

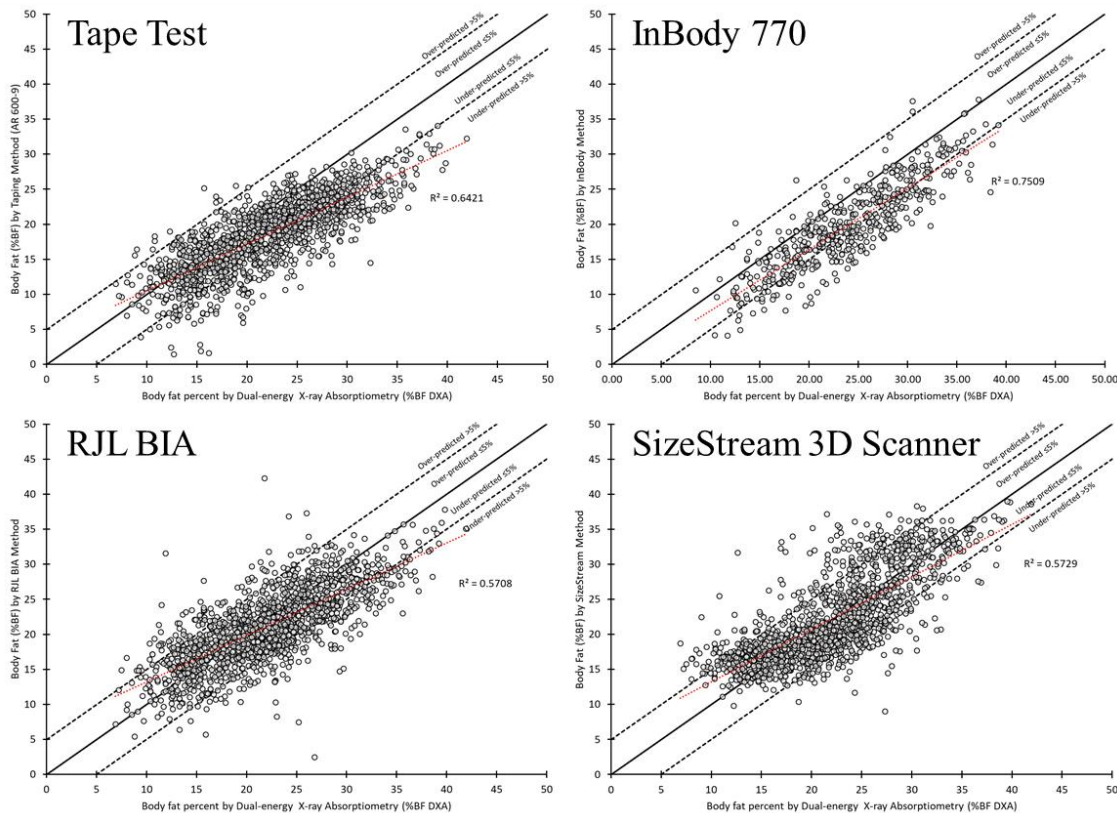
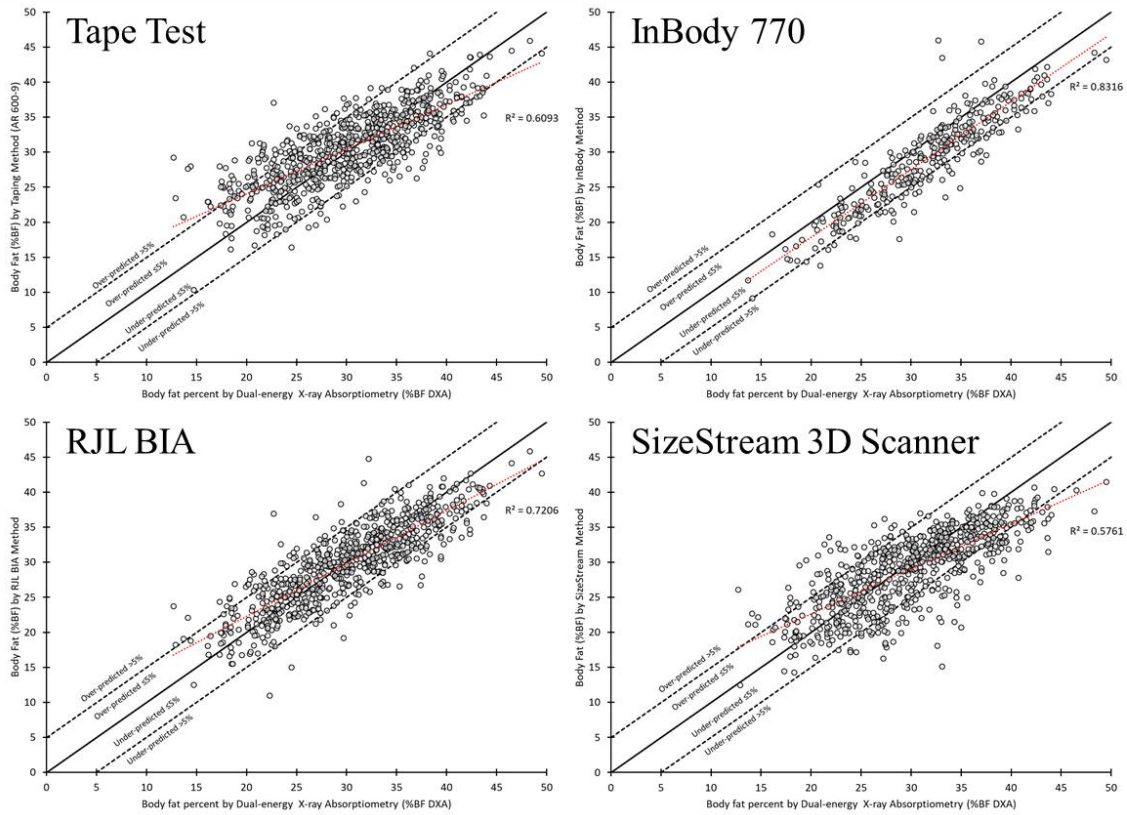

Figure 17. Simple comparison of body fat assessment methods to dual-energy x-ray absorptiometry (DXA) for women



4. Are %BF limits matched to physical readiness and military appearance?

4a. Body fat and performance

Across the sample of Marines, men and women were both (as expected) high performers relative to the PFT and CFT scores. Average PFT and CFT scores were 262 and 278 men, and 255 and 279 for women, respectively (Figure 18).

Figure 18. Box and whisker plot for ranges total scores of PFT (white boxes) and CFT (grey boxes) for men (left) and women (right)

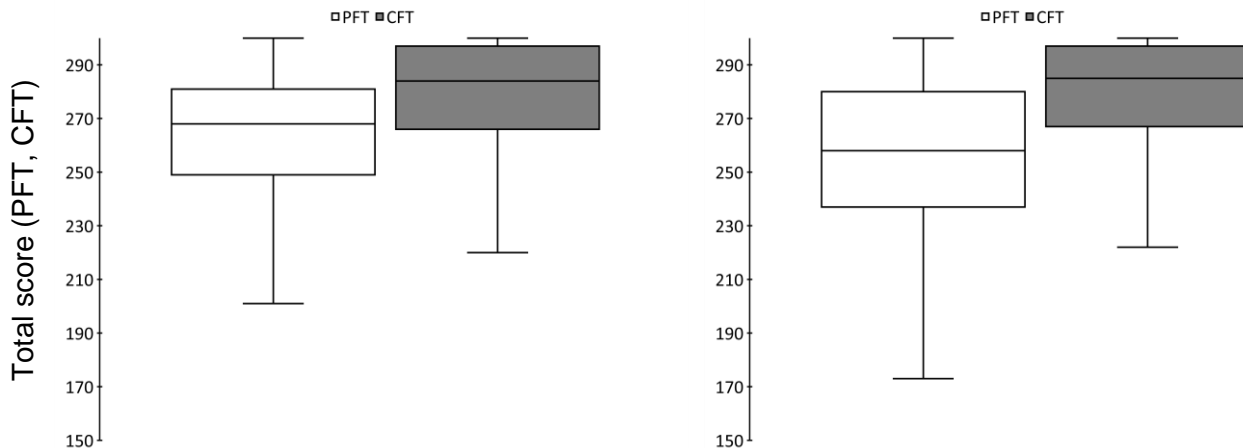

The relationship between %BF (DXA) to PFT and CFT scores is shown in Figure 19. Although this is a “soft” relationship, a downward trend of lower scores associated to higher %BF is evident. It is worth noting that the relationship between CFT and %BF is lower than that of PFT to %BF, which may be due the differences between the run events on the two tests. The CFT run events are shorter distances (880 yds and 300yds) than the 3 mile run event on the PFT.

Figure 19. Comparison of PFT and CFT scores to body fat (%BF) dual-energy x-ray absorptiometry (DXA)

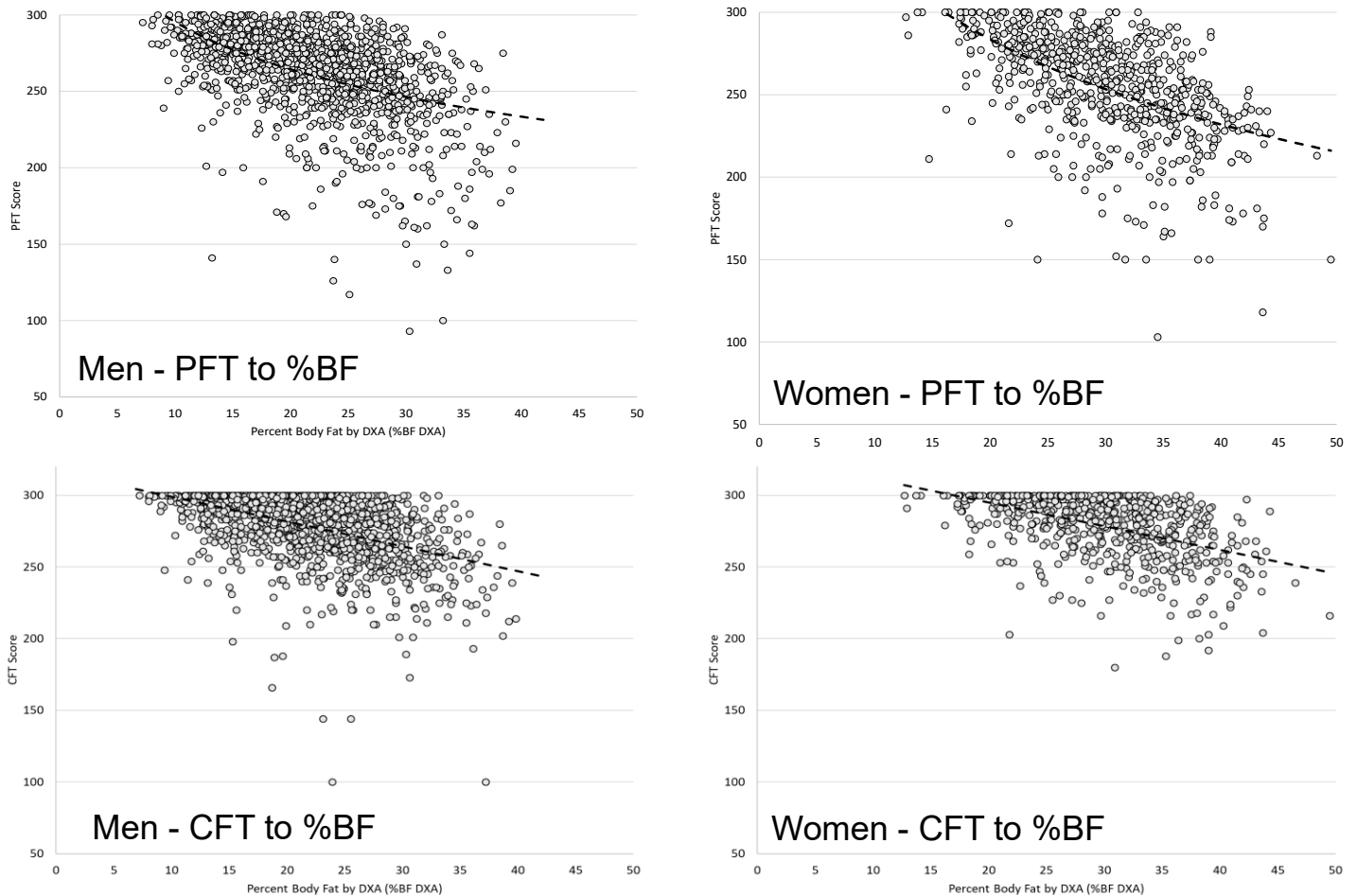

4b. Body fat distribution, with respect to means and standards.

Measures of %BF across the sample of both men and women represent a lean force, especially in comparison to that within the national population (age-matched). Figures 20 and 21 show the distribution of %BF (DXA) for men and women Marines, the mean values for each age group, and age-matched median values from a large US national sample (NHANES) (Kelly, Wilson & Heymsfield, 2009). These figures show that men and women Marines are well below national averages for each age group (men 3-4% lower; women 8-10% lower). The average %BF is also relatively low for

each age group of 17-25, 26-35, 36-45, and 46 and older for both men (20.7, 21.9, 23.7, and 23.4%) and women (30.2, 28.9, 30.3, and 31.7%).

Figure 20. Distribution of Marine men body fat (%BF) for the four age groups and their comparison to national averages. **Note:** Large dashed lines represent %BF limits for each age group, solid lines represent the mean of the sample, and smaller dashed lines represent national averages.

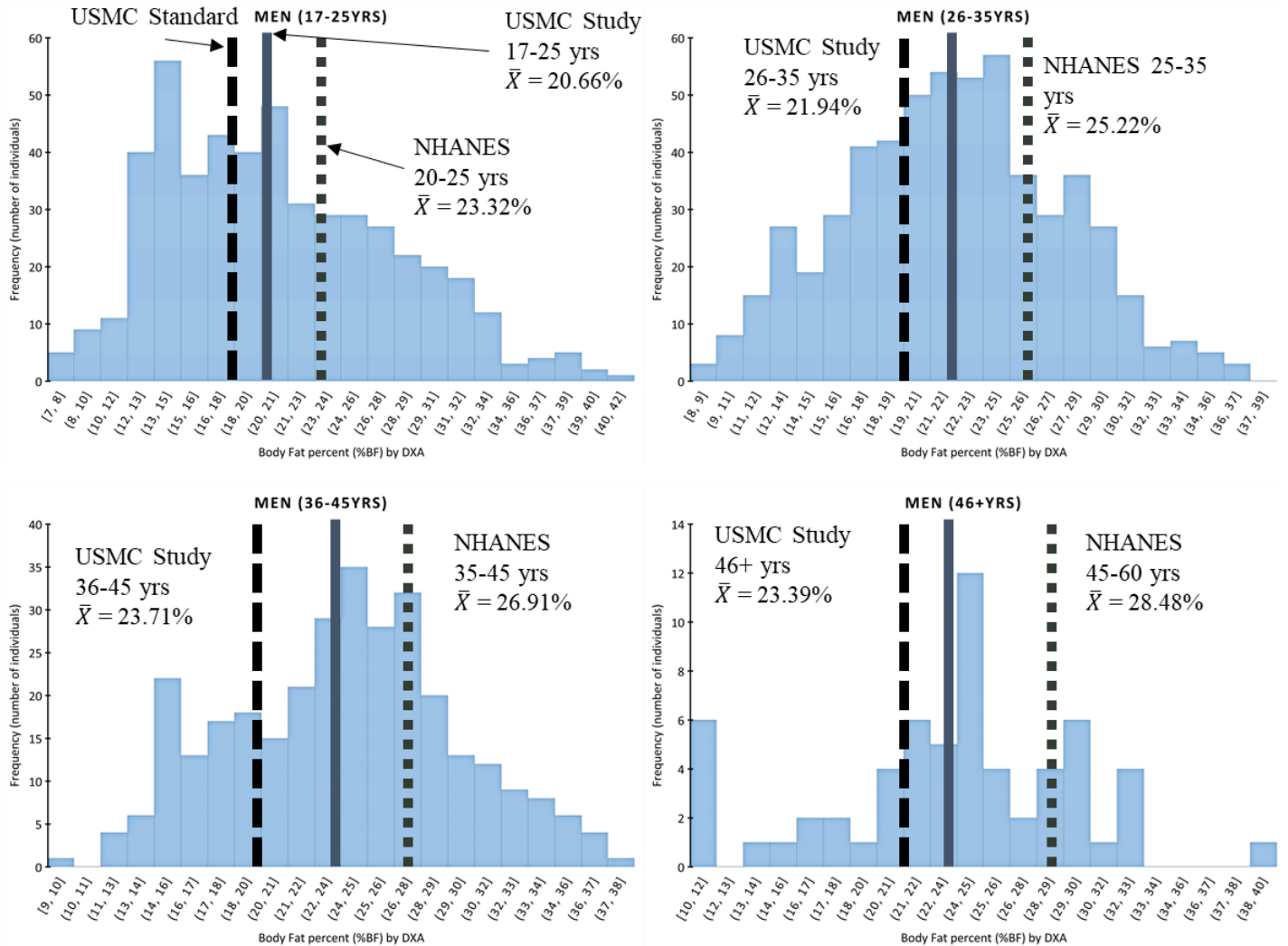
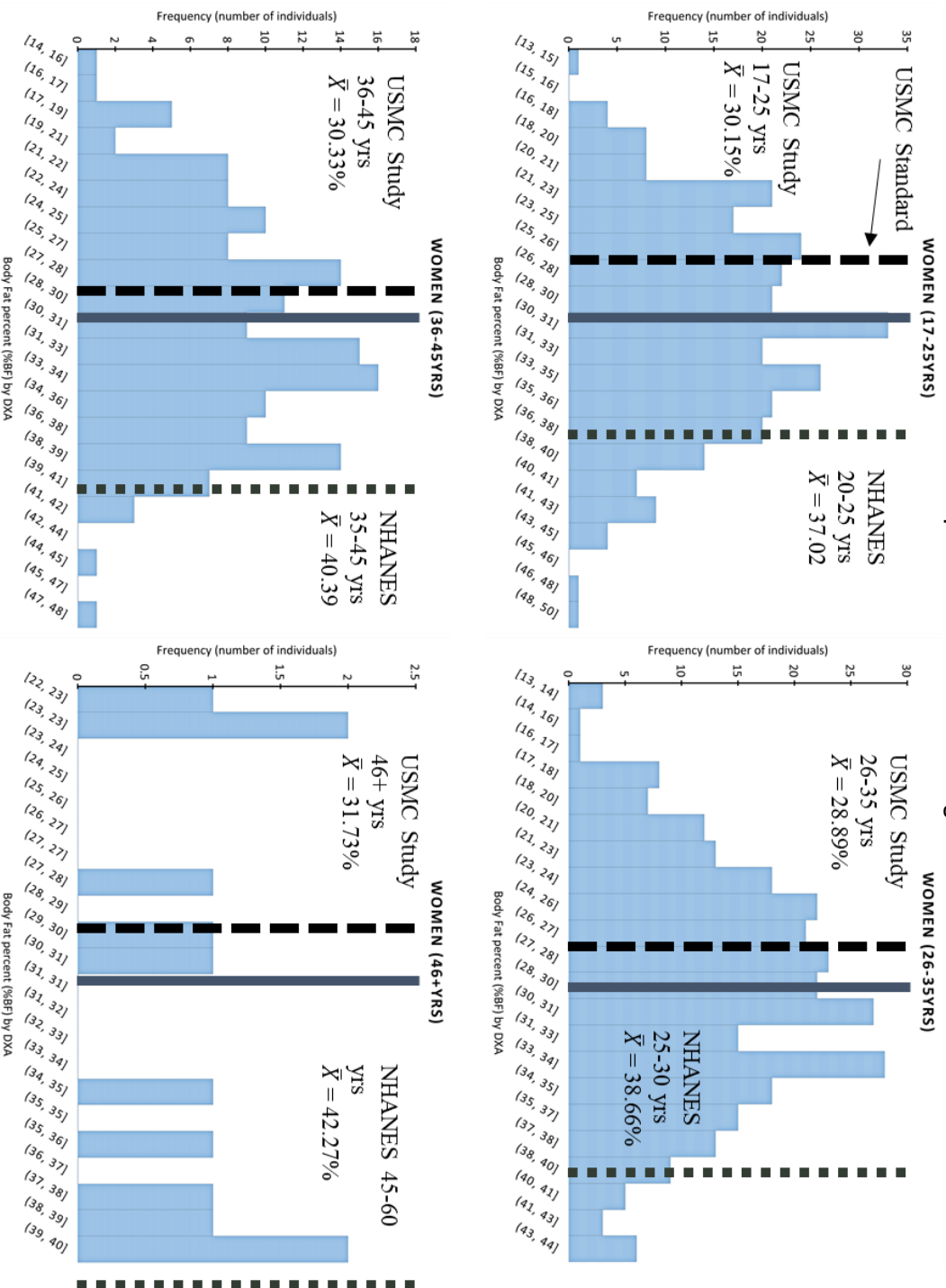

Figure 21. Distribution of Marine women body fat (%BF) for the four age groups and their comparison to national averages. **Note:** Large dashed lines represent %BF limits for each age group, solid lines represent the mean of the sample, and smaller dashed lines represent national averages.



4c. Body fat and appearance

Military appearance is important for a number of reasons (imposing warrior, and professional presence, respecting tradition, etc.). Therefore, it is important to consider the link between %BF and an element of military appearance. While it is outside the scope of this report to define what these thresholds in appearance as they relate to body composition should be; we have provided some mesh images of representative body shapes related to %BF for both men and women (Figure 22). It is important to note, that as shown in earlier assessments (Hodgdon et al., 1989; Friedl, 2004), anthropometric measures and surface scans are not always translatable to accurate assessments of body composition.

Figure 22. Representative mesh images of Marines across a range of %BF (by DXA) for both men (top row) and women (bottom row)

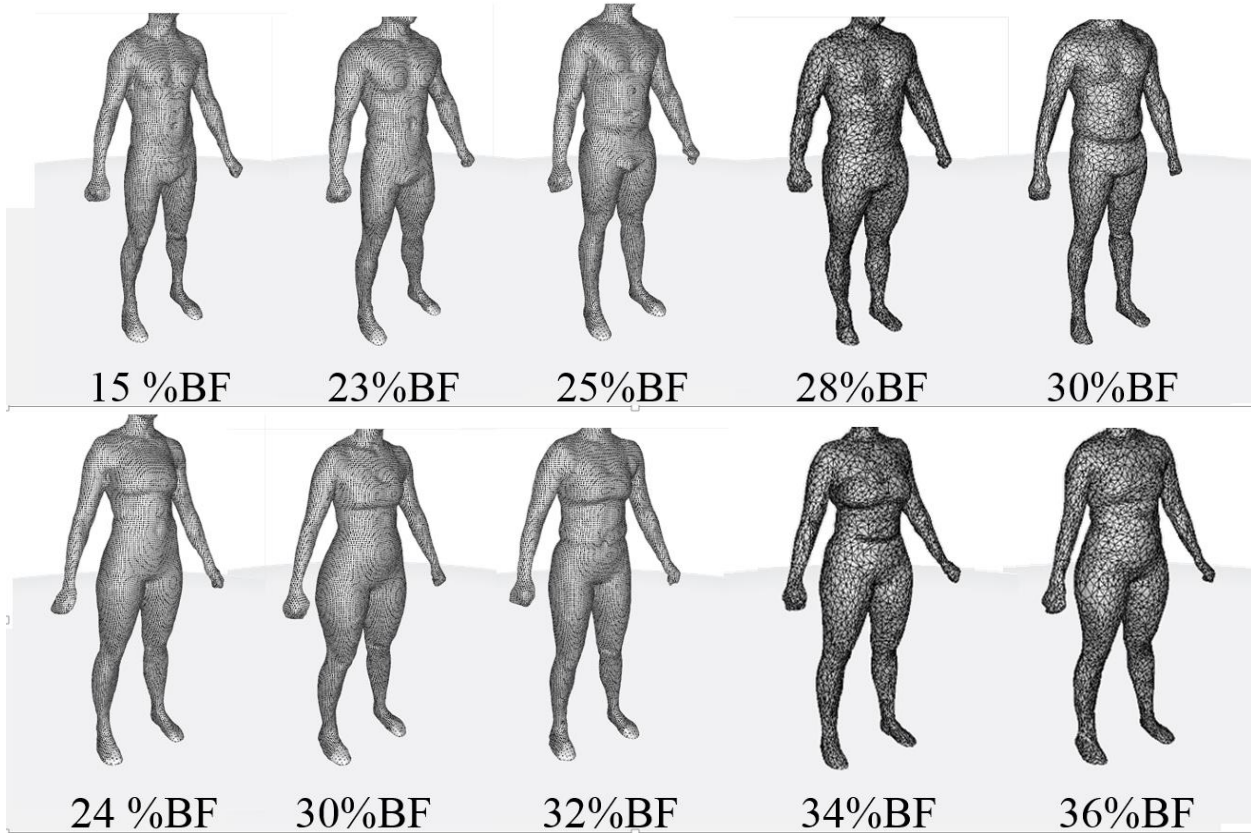

5. Would a final lab assessment of body fat help to protect good performers?

Based on the data presented in the previous sections, current methods have the potential for misclassifying some individual Marines that are within standards as being outside of standards (assessment of BCMAP, Figures 13-15). Some, or perhaps many, of these Marines would likely have achieved short term weight loss and would be in compliance with the weight-for-height screen. Of all the Marine participants in this sample, 2% of men and 6% of the women who failed weight screen and %BF standards by the tape test could be ‘saved’ by a second tier assessment using DXA. This is illustrated in Table 6.

Table 6. BCMAP breakouts by age groups where DXA would identify misclassification

	Men (n = 1,436)				Women (n = 692)			
Age group	17-25	26-35	36-45	46+	17-25	26-35	36-45	46+
N =	494	564	315	62	273	263	145	12
Exceed weight & body fat by tape but not by DXA (misclassified)								
#	3	10	11	2	14	19	6	1
(% of sample)	(0.6%)	(1.8%)	(3.5%)	(3.2%)	(5.2%)	(7.2%)	(4.1%)	(8.3%)
Total (proportion)	26 (2%)				40 (6%)			

Discussion and Implications

Key findings of this study highlight the interrelatedness of the legacy (pre-1980s) weight-for-height screening (i.e., BMI), %BF standards, and the linkages to physical performance. This last factor (linkage to fitness) is unique to the Marine Corps, as an organization with a “culture of fitness” and reinforces the basis for ensuring physical readiness. The “right” combination of these three evaluation factors is a multivariable problem that has more than one solution including, as one path, even stronger weighting of physical performance because of this central requirement to being a Marine.

Alternatively, additional testing of this concept, the weight screen and tape test could be abandoned in a clean sweep of legacy standards and methods and a bold modernization, perhaps replaced with a better practical method of body composition assessment that evaluates minimum lean mass goals and excess fat standards for every Marine regardless of size. This would address normal weight but “undermuscle” individuals currently ignored because of the weight-for-height screen and it would directly confront the question of how much is excess fat as applied to every Marine, not just large Marines (with continued recognition of sex-appropriate fat differences).

An increase in %BF limits for women is appropriate based on the observations that many of these women are excellent performers (e.g., CFT, PFT, appearance) yet too many fall above the current body fat limits. However, big changes should be made with caution and cannot be confidently predicted from this dataset which represents a cohort of Marine men and women that has been refined on the very basis of current body composition and fitness standards. For example, the existence of incumbent Marine women who can do an average of ~8 pull ups at a %BF that exceeds the current limit will not likely mean that new Marine recruits at this higher %BF would demonstrate this same performance. There is also no scientific formula that provides the “right” standards as none of these standards represent hard delineations (i.e., a Marine is not suddenly a bad performer when he/she exceeds a specified weight screen or body fat limit). There is however, a “biologically appropriate” range of body fat. If standards are set too low, where high performing Marines are engaging in unhealthy chronic weight loss efforts, the standards would be impairing rather than promoting physical readiness (Friedl et al. 1989). Based on a sub study from this larger study, the average %BF of fit and healthy young TBS officers (ages 21-30) has not changed from the 1980 DoD Fitness Panel recommendations that healthy fit young men and women average 15% and 25% body fat; in the TBS sample, mean values were 16 and 24% for men and women (Potter et al., 2022d). These values appear to represent a biological constant for physically mature (and nonobese) men and women before the influence of aging and the effects of personal health and fitness habits.

Upper limits for %BF standards would typically bracket an upper range percentile around this average to include more than just half of all good performers. For example, 20 and 30% as upper limits for healthy fit young men and women would represent 90-95% percentile of this group of future Marine Corps leaders (Potter et al. submitted).

The Marine Corps has devised an alternate approach, linking %BF standards to physical performance, as tested by the PFT and CFT; the intended purpose of these standards are to motivate physical fitness behaviors to optimize physical readiness. In the BCMAP, strict %BF standards are only a baseline standard; additional %BF units are earned with demonstrated higher physical performance, and even waived for excellent performance (PFT and CFT scores >285). Age allowances are also provided in three older age groups. Thus, a good performer in the oldest age group is actually held to a standard of 22% and 30% for men and women.

While additional data on Marine women is needed to confidently establish ideal %BF goals, the data on men repeatedly supports ~20%BF as a threshold associated with (but not necessarily “predictive of”) good aerobic performance. This was apparent from the data in this study where the association between %BF and performance metrics (PFT and CFT scores, and component tests) were soft and would not be defensible as performance selection criteria. In terms of health outcomes, 20%BF in men also represents a threshold beyond which intraabdominal fat begins to accumulate; there is relatively little difference in intraabdominal fat between men with the lowest levels of %BF and men with 20%BF, followed by an immediate steep linear increase, as demonstrated in professional football players (Bosch et al., 2014). Male-type intraabdominal fat is implicated in increased health risks. Women do not typically increase intraabdominal fat until much higher levels of adiposity (%BF) (Kvist et al., 1988). The Marine Corps focus on physical fitness and the linkage of %BF standards to fitness performance is further supported by evidence that regular physical activity is more important than body composition (the so-called “fit fat” concept); cardioprotective benefits even for lean men appear to arise primarily from physical activity (Ortega et al. 2018; Lee, Blair & Jackson, 1999). ***Adjustments to %BF standards should be made with some caution as the outcomes are not readily predictable; nevertheless, some increase in %BF seems appropriate, especially for women.***

In this study, we noted that the tape test did not predict %BF in women as reliably as the male tape test did for men (Potter et al., 2022a). As one indication of this, 6.3% of the women in this sample were misclassified as over their age-specific fat standard when they were not (based on DXA), while less than 1% of men were misclassified in this way. Another study published during the time of the BCMAP study evaluated females who have graduated from physically demanding courses which, prior to 2016, were closed to women. This study of a small group (n=13) of females showed they were substantially overestimated by the female tape test, with this small group averaging 20%BF by DXA but 29%BF by tape. Their physique which included normal waist and hip circumferences, but larger shoulders, biceps and thighs was not properly assessed by the female tape test developed on 1980s female sailors (McClung et al., 2022). The male tape test was not affected in this way when applied to a sample of 9 Marines assigned to the USMC Body Bearer platoon (Potter et al., 2022b). To be assigned to the Body Bearer platoon, Marines must be able to bench press ≥ 225 lbs and back squat ≥ 315 lbs among other physical requirements. Other studies have demonstrated that female recruits lose considerable fat and increase lean mass during basic training (based on DXA) but the female tape test does not capture this change,

with half of the women appearing to lose %BF and half appearing to gain %BF (Friedl et al., 2001; Foulis & Friedl, unpublished observations, 2021). ***The tape test should be replaced as soon as practicable; in the interim an additional “safety valve” such as a DXA or qualified BIA test could be used as a final check on any Marine failing their %BF standards.***

Physically fit humans are getting larger but not necessarily fatter. The trend to increased body size in the past few decades includes larger mass of elite athletes across a wide range of physical specialization (Norton & Olds, 2001). Increased lean mass has been promoted through new focus on strength training over the earlier focus on distance running when the original body fat standards were established in 1981. This is most evident in the recent proliferation of strength and conditioning programs (such as Marine Corps High Intensity Tactical Training “HITT”). As women compete for more of the traditionally male-oriented high risk training and elite warrior positions, average strength and body size may increase in this select group (McClung et al., 2022). This makes height and weight measures a ‘moving target’ for standards but adiposity has not changed in elite performers. Specifically, the relationship between fat mass and lean mass of individuals (e.g., percent body fat) appears to have remained constant for active fit young men and women for at least the past 40 years, even as total lean mass (and fat) continue to increase (Friedl, 2004; Potter et al., 2022d). What is clear from this study is that weight-for-height tables (BMI) have outlived their usefulness in the transition from weight tables alone (pre-1980 standards) to body fat standards. They are not good predictors of body composition, especially in a fitness-oriented organization; they unfairly stigmatize good performers who actually meet body fat standards but are labeled “overweight”; they miss a varying portions of the population who may actually carry substantial excess %BF, especially individuals who may be normal weight but have low muscle mass (“skinny fat”). This latter group may be increasing in prevalence due to high prevalence of sedentary behavior of the digital generations. ***There should be a phased plan to eliminate weight tables from the BCMAP.***

Known limitations of this study

This study was not designed as a statistically representative sampling of the US Marine Corps, nor was it intended to determine compliance with the BCMAP. This was a nonrandom “convenience” sample that also included a deliberate bias to over-recruit women through word-of-mouth (for an adequate sampling of both sexes). The intent of this study was to get a first look at how individual Marines were classified by the methods and standards in the BCMAP and to examine relationships between physical performance and body composition. It should also be stated again that the percentage of men and women “failing” to meet standard in this study would be substantially lower for the same group of individuals prepared for an official weigh-in; nearly half of the participants exceeding the weight-for-height screen were within ~10 pounds of their limit and would likely make short-term weight loss attempts to fall under these weight limits for an official weigh-in. Another predictive risk is the use of this data for “what if” analyses (e.g., increasing %BF limits). This can produce misleading results when applied to this population already shaped and selected by the existing standards,

suggesting predictive relationships between body composition and performance that may not hold true for the civilian or new recruit population. Additionally, this study took place during the COVID-19 pandemic, where weight gain has been reported as more prevalent in military and civilian populations (Legg et al., 2022; Wuederman et al., 2022; Koehlmoos, 2022), highlighting a need for reassessments and further studies. As one more caveat, this study did sample from several different major Marine Corps bases but did not test expeditionary Marines in Okinawa or specifically from smaller specialized groups such as Marine Forces Special Operations Command (MARSOC) units.

Future analyses of these data

Future analyses of the 3D full body scan data will help to define physical characteristics that may help to predict readiness status as defined by performance on physical test data available in this study (i.e., CMJ, CFT and PFT). There is high ethical risk in this type of analysis, especially if conducted without careful a priori hypothesis-driven question. The risk being a return to human somatotyping (“human body phenology”) involving inappropriate stereotyping of genetic differences. There are specific features of specialized physical performance that may constitute a clear low overlap zone (e.g., tall stature of basketball players, short forearm of powerlifters) (Norton and Olds, 2001). An example *a priori* hypothesis concerning physical readiness of Marines that might be pursued would be low abdominal circumference(s) relative to higher shoulder, thigh, or biceps circumferences associated with strength performance outcomes with similar measurement sites but different coefficients reflecting the association with performance for men and women. Currently, height and weight (expressed as BMI) and adiposity (percent body fat) are the physical characteristics that are used to define desired Marine performance. If valid indices emerge from future analyses, one could envision a future 3D scanner device in which standing bioelectrical impedance is built into the same device, providing information to the individual Marine about their physique and body composition as it relates to factors that are modifiable with health and fitness behaviors.

Summary and Conclusions

Forty years ago, the Marine Corps was directed, along with all the Services, to replace weight tables with a two tier system that used percent body fat as an enforceable physical readiness standard to prevent obesity (DoDD 1308.1). Weight tables were retained as a first tier screen to determine who might be both large and excessively fat, requiring further assessment for percent body fat. It was further directed that all services would use a field expedient circumference-based “tape test” to determine percent body fat, as pioneered by the USMC. The current study shows that the weight tables shield 8.9% of men and 30.3% of women from stringent body fat limits (i.e., exceed their fat standard but fall below the BMI screening limit). These individuals are “within standards” because they do not exceed the relatively liberal weight tables (body mass index 26.0 and 27.5 kg/m² for women and men, respectively) even though they carry more fat than the fat standards. Individuals who are underweight but have high percent body fat and very low lean mass (“skinny fat”) are also part of this shielded group; we define this group as BMI ≤ 25 kg/m² and %BF > 20% (men), > 30% (women). Although intended only as screening tools, the weight tables serve as a de facto standard, with many Marines reducing weight before annual testing to ensure they are not labelled as “overweight” even if they then meet fat standards (“tape out”). This was evident from the comparison of official annual testing data to the study data (not for record measurements).

The performance of the tape test was compared to a criterion method (dual energy x-ray absorptiometry) and misclassified 8.4% of men and 8% of women, with specific overestimation of 6.3% of women but only 0.6% of men. Other problems with the tape test for assessment of %BF in women have been identified and it has become evident that female body fat is not predicted as easily as for men where the abdominal circumference is very reliably associated with excess fat accumulation and physical fitness habits, acute health, and military appearance: (1) greater and more varied patterns of subcutaneous fat deposition in women make it more difficult to accurately predict excess fat in women compared to men; (2) the current tape test does not track reduction in percent body fat in women as well as it does for men; (3) the physique of strength trained women appears to cause a large overestimation of percent body fat compared to criterion measures such as DXA. Immediate changes made by the Marine Corps include an increase to female body fat standards, continued focus on the linkage between physical performance and body composition standards, and new consideration to an accurate “second check” body fat assessment (DXA or qualified BIA) before any Marine fails their %BF standards. A planned follow on to this study includes evaluation of an alternative practical and affordable body composition assessment method that will help to guide individual health and fitness behaviors, determine the most appropriate percent body fat and new lower limits of lean mass, appropriate to high performing and healthy women and men in the Marine Corps.

REFERENCES

- Bell CG, Walley AJ, Froguel P. (2005). The genetics of human obesity. *Nature Reviews Genetics*, 6(3), 221-234.
- Bosch TA, Burruss TP, Weir NL, Fielding KA, Engel BE, Weston TD, & Dengel DR. (2014). Abdominal body composition differences in NFL football players. *Journal of Strength and Conditioning Research*, 28(12), 3313-3319.
- Bosch TA, Carbuhn A, Stanforth PR, Oliver JM, Keller KA, & Dengel DR. (2019). Body composition and bone mineral density of division 1 collegiate football players, a consortium of college athlete research (C-CAR) study. *Journal of Strength and Conditioning Research*, 33(5), 1339.
- Bouchard C. (2008). Gene–environment interactions in the etiology of obesity: defining the fundamentals. *Obesity*, 16(S3), S5-S10.
- DoD Directive 1308.1 (1981). Physical Fitness and Weight Control Programs, Department of Defense Directive 1308.1, June 29, 1981.
- Fleck SJ. (1983). Body composition of elite American athletes. *American Journal of Sports Medicine*, 11(6), 398-403.
- Flegal KM, Graubard BI, Williamson DF, & Gail MH. (2005). Excess deaths associated with underweight, overweight, and obesity. *JAMA* 293(15), 1861-1867.
- Foulis SA, Hughes JM, Spiering BA, Walker LA, Guerriere KI, Taylor KM, Proctor SP, & Friedl KE. (2021). US Army basic combat training alters the relationship between body mass index and per cent body fat. *BMJ Military Health*.
- Friedl KE. (2004). Can you be large and not obese? The distinction between body weight, body fat, and abdominal fat in occupational standards. *Diabetes Technologies and Therapeutics* 6(5):732-749.
- Friedl KE. (2012). Body composition and military performance—many things to many people. *Journal of Strength and Conditioning Research*, 26, S87-S100.
- Friedl KE, Marchitelli LJ, Sherman DE, & Tulley R. (1991). Nutritional Assessment of Cadets at the U.S. Military Academy: Part 1. Anthropometric and Biochemical Measures. Technical Report No. T4-91, November 1990, US Army Research Institute of Environmental Medicine, Natick, MA. ADA231918.
- Friedl, KE, Westphal KA, Marchitelli LJ, Patton JF, Chumlea WC, & Guo S. (2001). Evaluation of changes in body composition in young women after a physical training program. *American Journal of Clinical Nutrition*, 73:268-75.
- Gallagher D, Heymsfield SB, Heo M, Jebb SA, Murgatroyd PR, & Sakamoto, Y. (2000). Healthy percentage body fat ranges: an approach for developing guidelines based on body mass index. *American Journal of Clinical Nutrition*, 72(3), 694-701.

General Accounting Office (1998). Gender Issues. Improved guidance and oversight are needed to ensure validity and equity of fitness standards. November 1998. GAO/NSIAD-99-9.

Harty PS, Sieglinger B, Heymsfield SB, Shepherd JA, Bruner D, Stratton MT, & Tinsley GM. (2020). Novel body fat estimation using machine learning and 3-dimensional optical imaging. *European Journal of Clinical Nutrition*, 74(5), 842-845.

Hodgdon JA, & Beckett MB. (1984a). Prediction of Percent Body Fat for U.S. Navy Men from Body Circumferences and Height. Naval Health Research Center, San Diego, CA, Technical Report No 84-11.

Hodgdon JA, & Beckett MB. (1984b). Prediction of Percent Body Fat for US Navy Women from Body Circumferences and Height Naval Health Research Center, San Diego, CA, Technical Report No. 84-29.

Hodgdon JA, Fitzgerald P, & Vogel JA. (1990). *Relationships between body fat and appearance ratings of US soldiers*. Technical Report T12-90, US Army Research Institute of Environmental Medicine, Natick, MA. ADA219632.

Junnila RK, List EO, Berryman DE, Murrey JW, & Kopchick JJ. (2013). The GH/IGF-1 axis in ageing and longevity. *Nature Reviews Endocrinology*, 9(6), 366-376.

Kelly TL, Wilson KE, & Heymsfield SB. (2009). Dual energy X-Ray absorptiometry body composition reference values from NHANES. *PloS One*, 4(9), e7038.

Kenney WL, & Hodgson JL. (1985). Variables predictive of performance in elite middle-distance runners. *British Journal of Sports Medicine*, 19(4), 207-209.

Koehlmoos T. Impact of obesity on force readiness, and military health systems in the US. C3 for Health International Health Seminar Series. London, UK; 26 April 2022. Invited Key Note Speaker.

Kvist H, Chowdhury B, Grangard U, Tylén U, & Sjostrom L. (1988). Total and visceral adipose-tissue volumes derived from measurements with computed tomography in adult men and women: Predictive equations. *American Journal of Clinical Nutrition*, 48: 1351–1361.

Lee CD, Blair SN, & Jackson AS. (1999). Cardiorespiratory fitness, body composition, and all-cause and cardiovascular disease mortality in men. *American Journal of Clinical Nutrition*, 69(3), 373-380.

Legg M, Stahlman S, Chauhan A, Patel D, Hu Z, Wells N. (2022). Obesity prevalence among active component service members prior to and during the COVID-19 pandemic, January 2018-July 2021. *Medical Surveillance Monthly Report*, Mar 1;29(3):8-16.

McClung HL, Spiering BA, Bartlett PM, Walker LA, Lavoie EM, Sanford DP, & Friedl KE. (2022). Physical and Physiological Characterization of Female Elite Warfighters. *Medicine & Science in Sports & Exercise*, 54(9), 1527.

MCO 6100.10 (1980). Marine Corps Order 6100.10, Weight Control and Military Appearance. Commandant of the Marine Corps. Washington DC. 23 October 1980.

MCO 6100.3A (2021). Marine Corps Order 6100.3A, w/Ch3, Weight Control and Military Appearance. Commandant of the Marine Corps. Washington DC. 23 February 2021.

NHLBI Obesity Education Initiative Expert Panel (1988). Clinical Guidelines on Identification, Evaluation and Treatment of Overweight and Obesity in Adults: The Evidence Report. National Heart Lung and Blood Institute, National Institutes of Health, Bethesda, MD.

Norton K, & Olds T. (2001). Morphological evolution of athletes over the 20th century. *Sports Medicine*, 31(11), 763-783.

Ortega FB, Ruiz JR, Labayen I, Lavie CJ, & Blair SN. (2018). The Fat but Fit paradox: what we know and don't know about it. *British Journal of Sports Medicine*, 52(3), 151-153.

Pollock ML, Mengelkoch LJ, Graves JE, Lowenthal DT, Limacher MC, Foster C, & Wilmore JH. (1997). Twenty-year follow-up of aerobic power and body composition of older track athletes. *Journal of Applied Physiology*, 82(5), 1508-1516.

Pontzer H, Yamada Y, Sagayama H, Ainslie PN, Andersen LF, Anderson LJ, Arab L, Baddou I, Bedu-Addo K, Blaak EE, & Blanc S. (2021). Daily energy expenditure through the human life course. *Science*, 373(6556), pp.808-812.

Potter AW, Tharion WJ, Holden LD, Pazmino A, Looney DP, & Friedl KE. (2022a). Circumference-based predictions of body fat revisited: Preliminary results from a US Marine Corps body composition survey. *Frontiers in Physiology*, 13, 868627.

Potter AW, Soto L, & Friedl KE. (2022b). Body composition of extreme performers in the US Marine Corps. *BMJ Military Health*.

Potter AW, Nindl LJ, Soto LD, Pazmino A, Looney DP, Tharion WJ, Robinson-Espinosa JA, & Friedl KE. (2022c). High precision but systematic offset in a standing bioelectrical impedance analysis (BIA) compared to dual-energy x-ray absorptiometry (DXA). *BMJ Nutrition, Prevention & Health*

Potter AW, Tharion WJ, Nindl LJ, McEttrick DM, Looney DP, & Friedl KE. (2022d). Body composition reference values of physically mature (21-30 year old) fit and healthy men and women. (submitted).

Rebuffe-Scrive M, Enk L, Crona N, Lonroth P, Abrahamsson L, Smith U, & Bjorntorp P. (1985). Regional human adipose tissue metabolism during the menstrual cycle, pregnancy, and lactation. *Journal of Clinical Investigation*, 75: 1973–1976.

Rebuffé-Scrive M, Andersson B, Olbe L, & Björntorp P. (1989). Metabolism of adipose tissue in intraabdominal depots of nonobese men and women. *Metabolism*, 38(5), 453-458.

Report on Nutrition and Health (1988). The Surgeon General's Report on Nutrition and Health. Summary and Recommendations. US Department of Health and Human Services. Public Health Service. DHHS (PHS) Publication No. 88-50211.

Study of Military Services Physical Fitness, Department of Defense, Manpower and Personnel (1981). Washington DC.

Sun SS, Chumlea WC, Heymsfield SB, Lukaski HC, Schoeller D, Friedl KE, Kuczmarski RJ, Flegal KM, Johnson CL, & Hubbard VS. (2003). Development of bioelectrical impedance analysis prediction equations for body composition with the use of a multicomponent model for use in epidemiologic surveys. *American Journal of Clinical Nutrition*, 77(2), 331-340.

Toombs RJ, Ducher G, Shepherd JA, & De Souza MJ. (2012). The impact of recent technological advances on the trueness and precision of DXA to assess body composition. *Obesity*, 20(1), 30-39.

Van Loan M, Hodgdon JA, & Kujawa K. (2001). Body composition in military or military eligible women. Final Report. MIPR 6JAKHM6745. US Army Medical Research and Materiel Command, Fort Detrick, MD. ADA400125

Vogel JA, Kirkpatrick JW, Fitzgerald PI, Hodgdon JA, & Harman EA. (1988). Derivation of anthropometry based body fat equations for the Army's weight control program. Technical Report No. 17-88, US Army Research Institute of Environmental Medicine, Natick, MA. ADA197706.

Vogel JA, Patton JF, Mello RP, & Daniels WL. (1986). An analysis of aerobic capacity in a large United States population. *Journal of Applied Physiology*, 60(2), 494-500.

Wright HF, & Wilmore JH. (1974). Estimation of relative body fat and lean body weight in a United States Marine Corps population. *Aerospace Medicine*, 45: 301-306.

Wright HF, Dotson CO, & Davis PO. (1981). A simple technique for measurement of percent body fat in man. *US Navy Medicine*, 72: 23-27.

Wright HF, Dotson CO, & Davis PO. (1980). An investigation of assessment techniques for body composition of women Marines. *US Navy Medicine*, 71: 15-26.

Wuederman M, Banaag A, Koehlmoos TP. A cohort study of BMI changes among US Army soldiers during the COVID-19 pandemic in 2020-2021. Obesity Week. San Diego, CA. 1-4 November 2022. Oral Presentation.